

3-22-2012

Rapid Prototype Development of a Remotely-Piloted Aircraft Powered by a Hybrid-Electric Propulsion System

Michael P. Molesworth

Jacob K. English

Follow this and additional works at: <https://scholar.afit.edu/etd>

Part of the [Industrial Engineering Commons](#)

Recommended Citation

Molesworth, Michael P. and English, Jacob K., "Rapid Prototype Development of a Remotely-Piloted Aircraft Powered by a Hybrid-Electric Propulsion System" (2012). *Theses and Dissertations*. 1299.
<https://scholar.afit.edu/etd/1299>

This Thesis is brought to you for free and open access by the Student Graduate Works at AFIT Scholar. It has been accepted for inclusion in Theses and Dissertations by an authorized administrator of AFIT Scholar. For more information, please contact richard.mansfield@afit.edu.



**RAPID PROTOTYPE DEVELOPMENT OF A REMOTELY-PILOTED
AIRCRAFT POWERED BY A HYBRID-ELECTRIC PROPULSION SYSTEM**

THESIS

Michael P. Molesworth, B.S.
Captain, USAF

Jacob K. English, B.S.
Captain, USAF

AFIT/GSE/ENV/12-M02

**DEPARTMENT OF THE AIR FORCE
AIR UNIVERSITY**

AIR FORCE INSTITUTE OF TECHNOLOGY

Wright-Patterson Air Force Base, Ohio

DISTRIBUTION STATEMENT A.
APPROVED FOR PUBLIC RELEASE; DISTRIBUTION UNLIMITED

The views expressed in this thesis are those of the author and do not reflect the official policy or position of the United States Air Force, Department of Defense, or the United States Government.

This material is declared a work of the U.S. Government and is not subject to copyright protection in the United States.

AFIT/GSE/ENV/12-M04

RAPID PROTOTYPE DEVELOPMENT OF A REMOTELY-PILOTED AIRCRAFT
POWERED BY A HYBRID-ELECTRIC PROPULSION SYSTEM

THESIS

Presented to the Faculty

Department of Systems and Engineering Management

Graduate School of Engineering and Management

Air Force Institute of Technology

Air University

Air Education and Training Command

in Partial Fulfillment of the Requirements for the

Degree of Master of Science in Systems Engineering

Michael P. Molesworth, Captain, USAF
Jacob K. English, Captain, USAF

March 2012

DISTRIBUTION STATEMENT A.
APPROVED FOR PUBLIC RELEASE; DISTRIBUTION UNLIMITED

AFIT/GSE/ENV/12-M04

RAPID PROTOTYPE DEVELOPMENT OF A REMOTELY-PILOTED AIRCRAFT
POWERED BY A HYBRID-ELECTRIC PROPULSION SYSTEM

Michael P. Molesworth
Captain, USAF

Jacob K. English
Captain, USAF

Approved:

Dr. David R. Jacques (Chairman)

Date

Dr. Richard G. Cobb (Member)

Date

Lt Col Frederick G. Harmon, PhD (Member)

Date

Abstract

Today, Remotely-Piloted Aircraft (RPA) provide users with unique mission capabilities, particularly on-demand overhead surveillance. However, a capability gap has been identified between the range and endurance of RPAs powered by internal combustion engines (ICE) and the reduced acoustic signature and smaller logistical footprint associated with electric-powered RPAs. This research, sponsored by the Office of the Secretary of Defense, aims at advancing systems engineering education by evaluating the utility of a tailored systems engineering approach. The tailored systems engineering approach used herein focuses on conducting a concept evaluation study on the rapid prototype development of a parallel hybrid-electric RPA (HE-RPA) and its ability to fill an identified mission capability gap. The concept evaluation utilizes a tailored systems engineering process to conduct a rapid prototype development and system evaluation. Two prototype RPAs and a support system are designed, integrated, and tested within a 13 month time window, in accordance with an established architectural framework. The integration of a parallel hybrid-electric system into an RPA demonstrated a potential reduction in acoustic signature and improves endurance over electric powered RPAs; however, immature technology and added system complexity result in overall performance that is currently on par with ICE-powered RPAs and only partially satisfies the capability gap.

Acknowledgements

We would like to first thank our thesis advisors Dr. Jacques, Lieutenant Colonel Harmon, and Dr. Cobb for their support in laying the technical and financial groundwork to make this research possible as well as their continued support in providing the guidance and direction along the way. We would like to thank Jeremy Boire for mentoring us so that we could successfully conduct flight test and get full utility out of the Kestrel Autopilot. We would like to thank Lieutenant Ausserer and Lieutenant Giacomo for embarking on the thesis journey with us and making it possible to accomplish as much as we did. We also appreciate the support that was provided to us by CESI and CLMax; without them, we would not have had the ability to fly in such a short amount of time. We would also like to thank the Office of the Secretary of Defense for funding the majority of this research so that we could have the hardware and contractor support necessary to build two RPAs and enhance our systems engineering educational experience. We are also thankful for the continued support and DTS help that Lynn Curtis provided.

Finally, we would like to thank our families for supporting us through the many hours of class work, research, meetings, and writing. We could not have accomplished this analysis without you.

- Jacob English

- Michael Molesworth

Table of Contents

Abstract.....	iv
Acknowledgements.....	v
Table of Contents.....	vi
List of Figures.....	ix
List of Tables.....	xii
List of Abbreviations.....	xiii
I. Introduction.....	1
1.1. Background.....	1
1.2. Motivation.....	2
1.3. Problem Description.....	4
1.4. Research Objectives.....	6
1.5. Research Scope.....	6
1.6. Research Methodology.....	8
1.7. Thesis Overview.....	8
II. Background.....	10
2.1. Chapter Overview.....	10
2.2. Identification of RPA Mission Gap.....	10
2.3. Motivations and Objectives.....	13
2.4. Previous Research.....	13
2.5. Hybrid Operational Modes.....	15
2.6. Power Sources.....	18
2.7. AFIT Aircraft Design.....	18
2.8. Acoustic Measurements and Propellers.....	19

2.9. Tailored Systems Engineering Process	20
2.10. Summary	21
III. Methodology.....	22
3.1. Chapter Overview.....	22
3.2. Operational Requirements.....	22
3.3. Systems Architecture.....	23
3.4. Early Systems Engineering and Planning	39
3.5. Tailored Systems Engineering Approach.....	41
3.6. Planned Schedule	46
3.7. System Development.....	48
3.8. Risk Analysis.....	52
3.9. System Integration.....	57
3.10. Evaluation.....	57
3.11. T&E Strategy.....	58
3.12. Bench/Ground/Flight Testing.....	59
3.13. Summary	63
IV. Results	64
4.1. Chapter Overview.....	64
4.2. HE-RPA System Development and Integration.....	65
4.3. AFIT 1 Taxi Testing.....	72
4.4. Airworthiness of RPA Airframe.....	74
4.5. HE-RPA Performance	76
4.6. Technology Readiness.....	81
4.7. Acoustics	81
4.8. Evaluation of Tailored Systems Engineering Process.....	90

4.9. Qualitative Risk Analysis Highlights	94
4.10. Quantitative Risk Analysis Results	95
4.11. Results Summary.....	102
V. Conclusions and Recommendations	103
5.1. Chapter Overview.....	103
5.2. Research Objectives	103
5.3. Evaluation of Tailored Systems Engineering Process.....	110
5.4. Information for a Decision Maker.....	111
5.5. Recommendations for Future Work	114
5.6. Summary	115
Appendix A. Concept of Operations	116
Appendix B. All Viewpoint 1 (AV-1).....	131
Appendix C. Textual Use Cases and Activity Diagrams (OV-5).....	136
Appendix D. Systems View 4 (SV-4) System Functionality Description.....	146
Appendix E. Operational Activity to System Function Traceability Matrix (SV-5)	152
Appendix F. System Evolution Viewpoint (SV-8).....	157
Appendix G. Technology Forecast (SV-9).....	159
Appendix H. Throttle Redirect Code: Procerus Kestrel Autopilot.....	161
Appendix I. Bench, Ground, and Flight Test Cards.....	164
Appendix J. Qualitative Risk Assessment.....	210
Appendix K. Test and Evaluation Management Plan (TEMP)	219
Works Cited	248

List of Figures

Figure 1: Planned RPA Capabilities, USAF [1]	11
Figure 2: Segmented ISR Profile	15
Figure 3: Systems Architecture Products; DoDAF version 2.0	26
Figure 4: Hybrid-Electric RPA Operational View (OV-1).....	28
Figure 5: Hybrid-Electric RPA OV-2	30
Figure 6: Operational Activity Model (Use Case Diagram).....	31
Figure 7: System Interface Description (SV-1)	33
Figure 8: SV-4, Provide Covert ISR “as-intended”	35
Figure 9: SV-4, Provide Covert ISR “as-built”	35
Figure 10: Defense Acquisition Management System.....	41
Figure 11: Systems Engineering V-Model [36].....	43
Figure 12: Planned HE-RPA Development IMS	47
Figure 13: Conceptual Parallel Hybrid-Electric System.....	48
Figure 14: Optimized Airframe Design Parameters	49
Figure 15: Preliminary Allocation of Airframe Components	50
Figure 16: CLMax Wing Loading Tests (15-ft Wingspan)	51
Figure 17: CLMax Wing Load Testing	51
Figure 18: RPA Control Model.....	52

Figure 19: HE-RPA network calculations	55
Figure 20: Estimated HE-RPA project duration in weeks	56
Figure 21: Test and Evaluation Hierarchy	58
Figure 22: Integrated Components.....	66
Figure 23: Integrated GCS Components.....	68
Figure 24: RPA Layout.....	70
Figure 25: Servo to Analog Conversion Board by Blue Point Engineering.....	71
Figure 26: Virtual Cockpit user interface	72
Figure 27: Tricycle Landing Gear Configuration.....	73
Figure 28: Tail-dragger Configuration.....	73
Figure 29: HE-RPA Bench Test Setup	78
Figure 30: Acoustic Measurement Location.....	83
Figure 31: 2-Blade 18" x 10 APC Propeller	84
Figure 32: 3-Blade APC Propeller	84
Figure 33: 3-Blade Carbon Fiber Propeller	84
Figure 34: 4-Blade APC Propeller.....	84
Figure 35: dB Measurements 2-Blade APC18 x 10 at 50-ft.....	85
Figure 36: dB Measurements 3-Blade APC15.75 x 13 at 50-ft.....	86
Figure 37: dB Measurements 3-Blade CF 16 x 11 at 50-ft.....	86

Figure 38: dB Measurements 4-Blade APC15.5 x 12 at 50-ft.....	87
Figure 39: Average Propeller dB at 50-ft	88
Figure 40: Planned HE-RPA Development Schedule	91
Figure 41: Actual HE PRA Development Schedule.....	92
Figure 42: HE-RPA network calculations	100
Figure 43: Actual Network Diagram	101

List of Tables

Table 1: DoD RPA Characteristics [1, 19, 8, 6, 5, 7]	12
Table 2: Functions Removed from "as-intended" Configuration	36
Table 3: Weakly Related System Functions	37
Table 4: Reduced Capability "as-built" Configuration	38
Table 5: Network Diagram Activities	55
Table 6: Planned Component/Hardware In-the-Loop Testing.....	60
Table 7: Planned Developmental Ground Testing.....	61
Table 8: Planned Flight Test Objectives.....	62
Table 9: Hybrid system bench test objectives and results	77
Table 10: Responsiveness Performance.....	89
Table 11: Electric Motor Acoustic Noise Testing Results.....	89
Table 12: Electric Motor Acoustic Frequency Testing Results	90
Table 13: Network Diagram Activities with Results	96
Table 14: Effects of Risk Mitigation	123

List of Abbreviations

AFRL	Air Force Research Lab	(ch3)
AV	All View	(ch3)
CDR	Critical Design Review	(ch3)
CESI	Cooperative Engineering Services Inc.	(ch4)
CG	Center of Gravity	(ch3)
COCOMS	Combatant Commanders	(ch1)
COI	Critical Operational Issue	(ch3)
CONOPS	Concept of Operations	(ch1)
COTS	Commercial off the Shelf	(ch3)
CRPD	Center for Rapid Prototype Development	(ch3)
CTP	Critical Technical Parameters	(App. K)
DAG	Defense Acquisition Guidebook	(ch3)
dB	Decibel	(ch4)
DoD	Department of Defense	(ch1)
DoDAF	Department of Defense Architecture Framework	(ch3)
DOTMLPF	Doctrine, Organization, Training, Material, Leadership, Personnel, or Facilities	(ch3)
DT&E	Developmental Test and Evaluation	(ch3)
EM	Electric Motor	(ch2)
EMI	Electromagnetic Interference	(ch5)
FAA	Federal Aviation Authority	(ch3)
FMV	Full Motion Video	(ch2)
GWOT	Global War on Terror	(ch1)

GPS	Global Positioning Satellite	(ch3)
HE	Hybrid Electric	(ch1)
HEPS	Hybrid Electric Propulsion System	(ch2)
IC	Internal Combustion	(ch1)
ICE	Internal Combustion Engine	(ch1)
IED	Improvised Explosive Device	(ch1)
IMS	Integrated Master Schedule	(ch3)
ISR	Intelligence Surveillance Reconnaissance	(ch1)
KPP	Key Performance Parameter	(App. K)
Li-Po	Lithium Polymer	(ch2)
LOE	Level of Effort	(ch3)
MOE	Measure of Effectiveness	(ch3)
MOP	Measure of Performance	(ch3)
MOS	Measure of Suitability	(App. K)
NAS	National Academy of Science	(ch1)
OEF	Operation Enduring Freedom	(ch1)
OIF	Operation Iraqi Freedom	(ch1)
OSD	Office of the Secretary of Defense	(ch2)
OEM	Original Equipment Manufacturer	(ch4)
OV	Operation View	(ch3)
PDR	Preliminary Design Review	(ch3)
PID	Proportional plus Integral plus Derivative	(ch3)
PWM	Pulse Width Modulation	(ch4)
RPA	Remotely-Piloted Aircraft	(ch1)

SA	Situational Awareness	(ch2)
SE	Systems Engineering	(ch1)
SEP	Systems Engineering Plan	(ch3)
SPL	Sound Pressure Level	(ch4)
SV	Systems View	(ch3)
TEMP	Test and Evaluation Master Plan	(ch3)
TRL	Technology Readiness Level	(ch4)
SIGINT	Signals Intelligence	(ch1)
UAV	Unmanned Aerial Vehicle	(ch1)
UAS	Unmanned Aerial System	(ch1)
USAF	United States Air Force	(ch1)
USN	United States Navy	(ch1)

I. Introduction

1.1. Background

Unmanned aerial systems (UASs) and the capabilities they provide have emerged as one of the most “in demand” capabilities the USAF provides the Joint Force [1]. These unmanned systems are valued by combatant commanders (COCOMS) for their versatility and persistence [2]. Throughout the past decade, the Department of Defense has relied heavily upon remotely-piloted aircraft (RPA), also referred to as unmanned aerial vehicles (UAV), to perform a majority of intelligence, surveillance, reconnaissance (ISR) missions. RPA’s have made significant contributions to the Global War on Terror (GWOT) including the locating, monitoring, and neutralizing of enemy combatants, identification of and detonation of improvised explosive devices (IED), and the collection of signals intelligence (SIGINT). By 2008, RPAs (excluding hand-launched platforms) had flown almost 500,000 flight hours in support of Operation Enduring Freedom (OEF) and Operation Iraqi Freedom (OIF). The hand-launched RQ-11 Raven had flown in excess of 110,000 flight hours supporting deployed forces [2].

Remotely-piloted aircraft not only provide information to senior decision makers, but also to Joint and Coalition forces operating in the field. In order to effectively perform persistent ISR “stare” missions [2], RPAs must gather data for prolonged periods of time without being discovered. Due to the high energy density of fossil fuels, mid-endurance (4-12 hrs) and long-endurance RPAs (12+ hrs) typically have internal combustion (IC) engines. The problem with IC engines has been that they generate excessive noise, limiting the proximity of the ISR gathering RPA to the area of interest.

Mid-endurance and long-endurance RPAs powered with IC engines typically operate within a range (typically high altitude) necessitating the use of costly optics and sensors for ISR data collection. These features preclude long endurance RPAs from being operated by field level units in austere environments with limited logistical support. These costly features also limit RPA availability, restricting their use to the highest priority missions. The primary goal of the United States Department of Defense (DoD) Unmanned Systems Integrated Roadmap FY2009-2034 is to propose feasible means to capitalize on unmanned technologies in order to allow the warfighter to conduct more missions effectively with less risk. Included within this goal is the development and procurement of systems capable of carrying out missions in a covert manner, which, until recently, has received minimal emphasis [2, 3]. Reductions in both the acoustic and thermal signatures of RPAs will facilitate attainment of these goals and may pave the way for field and/or forward deployed units to access the benefits of the mid to long endurance RPAs.

1.2. Motivation

The push for advancements in UAS and RPA technology and increased procurements is driven by the desire to keep unmanned systems on pace with mission demands to support the GWOT [2, 3]. The evolution of US fighting forces over the last decade has resulted in the creation and utilization of smaller more agile special operations teams often operating within hostile and arduous terrain. Given the extreme mobility requirements of these forces in regions such as the mountains of Afghanistan and Pakistan, or the complex urban sprawl of Baghdad, the size and weight of their

equipment is a critical factor [4]. These special operations forces need to balance their desire to make units smaller with their desire to have the covert and/or standoff ISR capabilities UAS provide. A tradeoff needs to be made between the mobility of their units and the capability of their systems.

Due to the quantity and dispersed nature of special operation taskings, utilizing high-value low-density UAS and RPAs with large logistical footprints (often approaching that of manned aircraft), such as the long endurance MQ-1 Predator, MQ-9 Reaper, or RQ-4 Global Hawk, is not feasible in most situations. In an effort to reduce the logistical footprint, yet maintain the desired persistent ISR capabilities, several smaller UAS (hence referred to as RPA's) such as the Aerosonde Mark 4.7 UAV, the Boeing ScanEagle, and the Northrup Grumman MQ-5B Hunter have been introduced [5, 6, 7]. While these systems are capable of delivering the desired persistent ISR to field level units, they still require a level of logistical support rendering them impractical for use by highly mobile units. Additionally, they are powered by IC engines, precluding their use as a covert (or low observable) ISR collection platform, especially for the utilization of payloads optimized for lower altitudes. Although significantly cheaper than the more advanced MQ-1, MQ-9, and RQ-4, the cost of these systems still precludes them from widespread use.

UAS and RPAs are now so entrenched and valued in military operations, that once routine, albeit hazardous, missions are sometimes cancelled unless they have support from an RPA. Ultimately, special operations and field level forces need a persistent ISR capability that would allow them to attain the capabilities of the more

logistically demanding and more expensive systems. The need for such a system has not gone unnoticed. In 2003, both the Defense Science Board and the US Air Force Scientific Advisory Board added a small (less than 50 lbs), low-observable (near-silent) RPA to their lists of recommended capabilities [1]. In an effort to address this need for a small, near-silent, RPA with the desired persistent ISR capabilities, in conjunction with the goals set forth in the DoD's Unmanned Systems Integrated Roadmap FY2009-2034, this research involves the development and evaluation of an RPA powered by emerging hybrid-electric (HE) technology.

1.3. Problem Description

Currently, an RPA platform possessing the desired endurance and near-silent operation capabilities needed for remote, longer duration, missions does not exist. As mentioned above, vehicles such as the Aerosonde Mark 4.7, the Boeing ScanEagle, and the Northrop Grumman MQ-5B Hunter possess the desired endurance, but are larger and lack the desired near-silent operation. Electric, battery powered, vehicles such as the AeroVironment RQ-11 Raven have been used extensively due to their man-portable nature and their ability to fly over target areas relatively unnoticed. They are powered by a small electric motor allowing them to fly considerably lower, making them ideal for payloads optimized at lower altitudes. However, electric powered RPAs such as the RQ-11 Raven do not possess substantial endurance due to the lower specific energy levels of the required batteries, with typical flight times of 60-90 min [8].

The US Air Force is exploring the potential of alternative power sources in order to expand the capabilities of RPA platforms. Previous research in this area has resulted

in a concept for a small, HE-RPA. The concept entails the design and fabrication of an RPA possessing both the endurance and range capabilities of RPAs powered by an internal combustion engine (ICE), and the reduced acoustic signature and smaller logistical footprint associated with electric-powered RPAs. The envisioned concept will consist of an RPA powered by an HE propulsion system (HEPS), integrated into an RPA airframe optimized for the HEPS. A concept such as this has yet to be demonstrated as a viable option for enhancing the US Air Force's RPA capabilities.

Given that the demand for RPA capabilities will continue to grow at astounding rates, there exists an attended need for the DoD's acquisition workforce to quickly acquire and develop weapon systems in response to rapidly changing threats [9]. Good systems engineering is vital to a successful acquisition program and hence the fielding of the desired capabilities. However, the accumulation of systems engineering and management processes and controls over the years is believed to have hindered the ability of the acquisition workforce to deliver systems and capabilities in a timely manner [9]. In 2007, at the request of the Deputy Assistant Secretary of the Air Force, the National Academy of Science (NAS) conducted a study to examine the role that systems engineering play in the defense acquisition lifecycle. One of the key recommendations made by the NAS, was to use a systems engineering process specifically tailored to the application in lieu of the rigidly evolved process currently used today [9]. In order to capitalize on the rapid growth in RPA technology, such as the aforementioned HE technology, and to get these systems and their capabilities into the hands of the warfighter, a tailored systems engineering approach needs to be explored for small HE-RPA procurement.

1.4. Research Objectives

The purpose of this research was to utilize a tailored systems engineering approach to develop and evaluate a hybrid-electric (HE) RPA prototype against a concept of operations (CONOPS), within an accelerated 13 month time window. The RPA prototype was to be tested and evaluated in a fully integrated system. At a more discrete level, the effort would determine:

- *If current HE technology exists as a viable option for a small RPA;*
- *If an airframe optimized for an HEPS system is airworthy;*
- *If an HE control strategy can be developed and implemented into an RPA;*
- *If an HE system can be successfully integrated into an RPA;*
- *If an HEPS improves the flight endurance of an RPA over an RPA equipped with a non-HE system;*
- *If the HE system results in a reduced acoustic signature;*
- *If the HE powered RPA meets capability requirements set forth in a CONOPS;*
- *If a streamlined systems engineering process can enhance rapid prototype development and demonstration.*
- *If the HE-RPA system is a viable candidate for future development.*

1.5. Research Scope

This effort was limited to a 13 month time window. Within this time period, previous research conducted by Harmon et al [10, 11] was utilized to procure two identical airframes and to develop the hybrid-electric propulsion system and the associated control strategy, control hardware, and control software. The first airframe

was configured with an ICE and was utilized to establish baseline airframe performance characteristics such as flight endurance, control performance, and acoustic signature. The second airframe was utilized as an integration and evaluation platform for the HE-propulsion system; a prototype of the envisioned concept. System evaluations were to consist of a series of bench testing, ground testing, and flight testing events.

Due to the 13 month time restriction and an inherent budget limitation, it was unrealistic to produce a production representative system as envisioned within the CONOPS. Therefore, a tailored SE process was utilized in order to produce a prototype system within the given constraints. As a result, the targeted capabilities for the prototype were scaled back from the full set contained in the CONOPS. This configuration is referred to the “as-built” configuration. A fully capable system configuration is referred to as the “as-intended” configuration. The systems architecture includes both the “as-built” and “as-intended” configurations in order to acknowledge and to understand the current deviations from a fully capable system. The results of the system evaluations and the tracked deviations from the “as-intended” configuration were used to characterize the resources and remaining effort required to achieve the “as-intended” configuration of the RPA. The anticipated capabilities of the “as-intended” configuration were extrapolated from the tests accomplished on the “as-built” configuration of the RPA. An evaluation of the tailored systems engineering approach was also included within the context of this research.

There were ongoing parallel efforts and research associated with the fabrication and characterization of the hybrid propulsion system, RPA flight control strategies, and

propeller optimization. These efforts only receive a cursory discussion when necessary. Additional information is available in Harmon [11], Ausserer [12], Giacomo [13] and Rotramel [14].

1.6. Research Methodology

The research objectives were divided into four distinct phases. Phase one consisted of early systems engineering planning and the development of a systems architecture. Phase two consisted of airframe procurement and the development and fabrication of the HEPS. Phase three focused on systems integration and baseline testing. Finally, phase four entailed integrated testing and an overarching concept evaluation effort.

This investigation utilized a tailored systems engineering approach in order to evaluate the HE-RPA concept within a 13 month time window. This approach took into account the need to define system requirements via an envisioned CONOPS, identify alternative solutions, design and development of a functional system(s), and the development and execution of evaluation criteria. Throughout all phases, established systems engineering practices were used when and where they were deemed appropriate.

1.7. Thesis Overview

Chapter I provides This thesis begins with an overview and the motivation for this research effort along with limitations and objectives. Next is a background on the origination of the HE- RPA concept, which leads into an examination of the requisite airframe, propulsion system, and control system components. The rationale for utilizing a tailored systems engineering approach throughout this effort is also covered. Following

is a discussion of the logical progression needed in order to mature the HE concept into a functioning prototype. System performance measures and test results are captured and discussed next. Finally, the thesis concludes with a discussion on the suitability of the HE-RPA concept as a means of providing the desired persistent ISR capability and near-silent operation. Recommendations for possible future efforts are also discussed.

II. Background

2.1. Chapter Overview

This chapter begins with a discussion on RPA mission gap analysis and the motivation and objectives of the research effort. Next a discussion of previous research regarding HE-RPAs is presented. Finally, a discussion on using a tailored systems engineering process and the applicability to a rapid prototype development effort.

2.2. Identification of RPA Mission Gap

The 2011 United States Air Force Posture Statement [15] stated that the US Air Force currently has more than 90 percent of all available ISR assets deployed. In an effort to relieve the operational strain on existing assets, the US Air Force also stated that it planned to expend \$8.2 billion (FY12) on expanding and supporting ISR capabilities. This included an increase in MQ-9 Reaper production to 48 per year. Providing ISR capability to the Joint Force remains a chief priority of the US Air Force.

While the US Air Force is actively pursuing procurement and sustainment of its medium RPAs as noted above (procurement of RQ-4 Global Hawk Block 40 was canceled just prior to completion of this document), it is also laying out guidelines for the future utilization of Small Unmanned Aircraft Systems (SUAS), hence referred to as small RPAs. The US Air Force UAS Flight Plan 2009-2047 [1] identified a need to pursue multi-mission small RPAs; aircraft that close the gap between man-portable and Predator and/or Reaper (MQ-1/9) capabilities. The focus here is on single systems that can achieve multiple effects/capabilities at a tactical level. Figure 1 from [1] further

illustrates this gap. The gray columns in Figure 1 indicate USAF aircraft mission gaps and the red highlights emphasize the specific RPA gaps addressed herein.

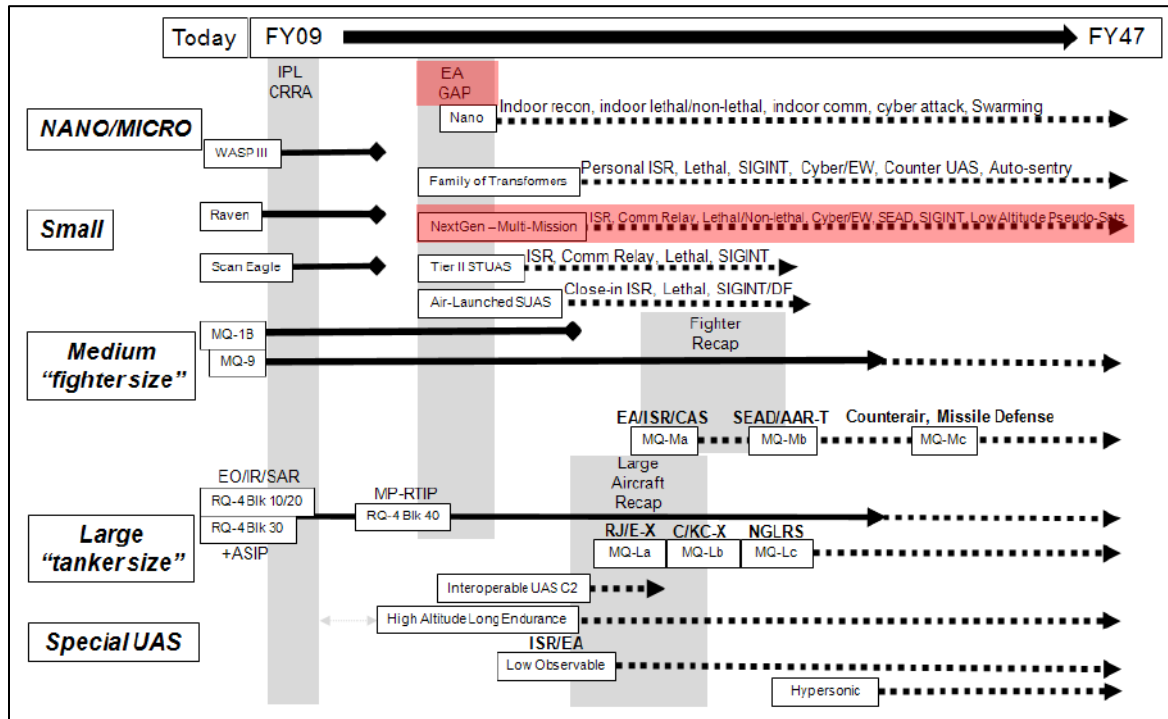

Figure 1: Planned RPA Capabilities, USAF [1]

A similar need was identified in a 2009 briefing by the US Army UAS Center of Excellence [16]. This briefing identified the US Army’s need for RPAs with the following capabilities:

- Provide full motion video (FMV) to soldiers on the move;
- Increase Tactical Commander situational awareness (SA);
- Provide RPA products at multiple levels;
- RPAs with multiple configurations for tactical flexibility.

In addition, Brigadier General Edward M. Reeder Jr., Commander US Army Special Forces Command, stated that many of the units under his command were asking for better, smaller, multipurpose RPA systems. Many of the units purchased the Silver Fox for its mission endurance and relatively small logistical footprint [17]. The US Army's RPA capability gaps essentially mirror those of the US Air Force.

While examining RPA requirements development, Patterson and Brescia [18] identified an additional desire for naval units to increase the flight duration of small RPAs to 8-10 hrs, include automatic engine start, and add onboard power generation [18]. Included below in Table 1 is a non-exhaustive list of current DoD RPA platforms and their primary characteristics. Of note, there currently is an extreme jump in mission capability when the tradeoff is made between battery powered RPAs and fossil fuel ICE based RPAs.

Table 1: DoD RPA Characteristics [1, 19, 8, 6, 5, 7]

Remotely Piloted Aircraft System	Weight	Wingspan	Length	Airspeed	Altitude	Endurance	Fuel Source	Range	Payload	Armed
RQ-4B Global Hawk	32, 250 lb	116.2 ft	44.4 ft	340/310 kts	60,000 ft	28 hr	JP-8	5400 nm	3000 lb	No
MQ-9 Reaper	10,500 lb	66 ft	26 ft	240/120 kts	50,000 ft	14-20 hr	JP-8	1655 nm	3750	Yes
MQ-1 Predator	2250 lb	55 ft	27 ft	118/70 kts	25,000 ft	16-24 hr	AVGAS	500 nm	450 lb	Yes
MQ-5 Hunter	1950 lb	34 ft	23 ft	110/70 kts	18,000 ft	21 hrs	JP-8	200 KM	280 lb	Yes
RQ-7 Shadow 200	375 lb	14 ft	11.3 ft	110/60 kts	14,000 ft	5-6 hr	AVGAS	125 KM	60 lb	No
Aerosonde Mark 4.7	38 lb	11.8 ft	5.7 ft	60/50 kts	15,000 ft	10 hr	Gasoline	1000 nm	12 lb	No
ScanEagle	37.9 lb	10.2 ft	3.9 ft	70/49 kts	16,400 ft	15 hr	Gasoline	60 nm	13.2 lb	No
Silver Fox - B4	20 lb	7.8 ft	4.8 ft	50/30 kts	16,000 ft	8 hr	Gasoline	20 nm	5 lb	No
Puma UAV	13 lb	9.2 ft	4.6 ft	45/20 kts	10,000 ft	2 hr	Battery	10 nm	2-4 lb	No
RQ-11 Raven	4.2 lb	55 in	35 in	26 kts	15,000 ft	1.5 hr	Battery	6 nm	3/4 lb	No

There is multi-service consensus on the need for a tactical, flexible and multi-modal ISR RPA system with greater endurance than what is currently available in battery powered systems.

2.3. Motivations and Objectives

Small unmanned aircraft systems and remotely-piloted aircraft provide a critical ISR capability to the military warfighter. Currently, small RPAs powered by ICEs (gasoline or diesel) generate mission compromising acoustic and thermal signatures and require taxing logistical support. Small electric-powered RPAs lack the endurance and range desired by warfighters [20].

The acoustic signature is notable because the development of RPAs with reduced acoustic signatures is included as an objective in the Unmanned Aerial Systems Roadmaps published by the Office of the Secretary of Defense [21, 3]. It is inferred from the OSD reports that the ability to ingress and egress into and out of a hostile target area with a small RPA (less than 50lbs) propelled by an ICE with an electric powered , near-silent, and low altitude surveillance capability would fill a significant gap in current RPA capabilities. An RPA with a HE- propulsion system could provide the desired military ISR capability by combining the advantages of both the ICE and electric power systems.

2.4. Previous Research

Previous HE-RPA research conducted by Harmon et al [10, 11, 20] and Hiserote [20] was mostly limited to analytical investigations. The current research effort leveraged funding provided by OSD to facilitate systems engineering education. In order to characterize the impact of using a tailored systems engineering approach, a technical challenge needed to be identified and addressed. This proved to be an ideal opportunity to bring together the technical challenge of the small HE-RPA concept and an evaluation of a tailored SE approach.

As defined in the CONOPS, Appendix A, two key performance parameters for the HE-RPA and the ICE RPA were a long and quiet loiter. If a longer loiter than that of an electric motor (EM) powered RPA was required, and a quieter loiter than that of an ICE powered RPA was required, then an HE-RPA was a possible solution. The HE-RPA was designed to take advantage of the strengths of both EM and ICE powered RPAs by optimizing the system based on the propulsion system requirements for each operational mode.

Some hybrid electric propulsion system (HEPS) work has been pursued by others with the intent to integrate the HEPS into an RPA. Koster et al [22] bench tested an HEPS that included an ICE and an EM but did not include a propeller. Koster et al also incorporated a dual electric propulsion system into an RPA designed by a Daniel Webster College team and flew the RPA for one flight. Although the RPA crashed during the first flight due to a strong wind gust, they were able to show that flying an RPA with more than one electric propulsion system was possible. Although Koster et al raised the bar by flying a hybrid system with two electric power sources, an HE-RPA has not yet been flown that uses both an ICE and an EM.

Glassock [23] designed an HEPS including an ICE and an EM for the purpose of reducing the size of the ICE required for flight. Glassock showed that by using an EM to provide additional power during takeoff, a smaller ICE was required; a 5% increase in weight for the EM resulted in 35% more thrust power. Although Glassock did not integrate the HEPS into an RPA and flight test the RPA, Glassock's ground testing

showed the potential capability of an HE-RPA, including the potential to operate in an “acoustic” stealth mode by having an EM only mode.

2.5. Hybrid Operational Modes

An ideal operational mission profile was developed by Harmon and Hiserote [20]. Their ideal mission profile referred to as a “segmented ISR mission profile” is shown in Figure 2. Descriptions for each phase including taxi, takeoff, and landing phases are presented below.

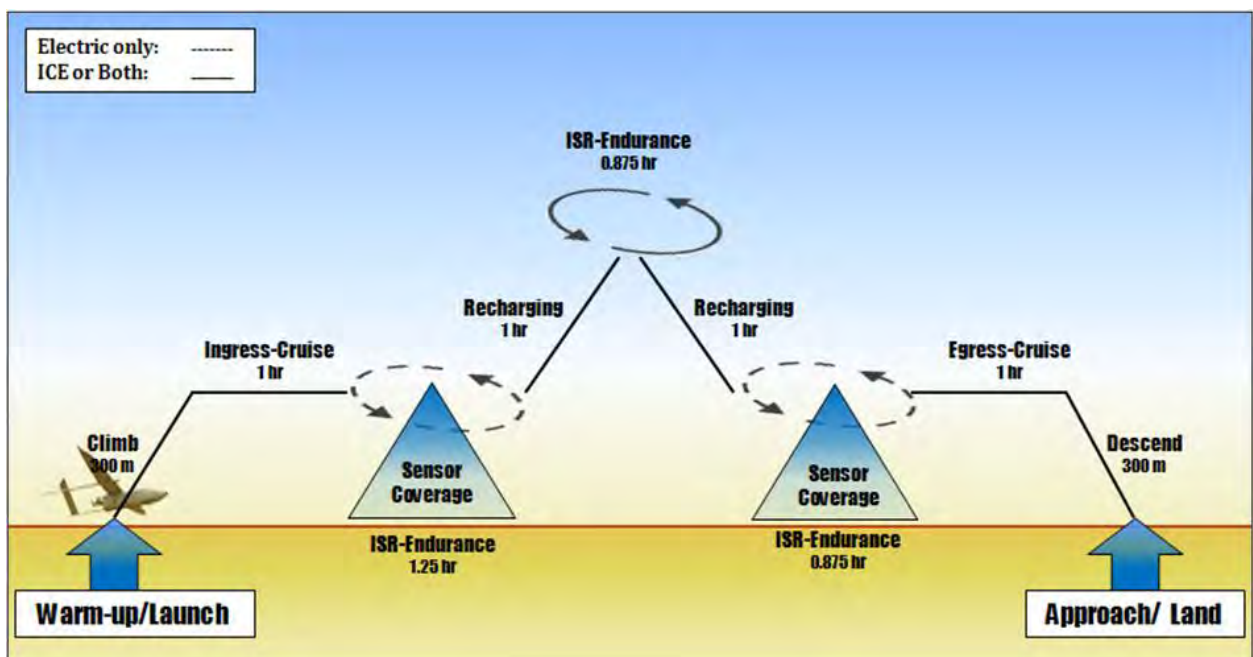

Figure 2: Segmented ISR Profile

2.5.1. Taxi

Taxi does not require tremendous power and can be conducted in ICE only or dual mode. The HE-RPA using less fuel and battery power during taxi reserves more for other segments of the mission. Since not a lot of time is spent in taxi mode, not a lot of effort was placed on optimizing the taxi mode.

2.5.2. Takeoff and Climb

Takeoff and climb requires the maximum amount of power. For an HE-RPA, the HEPS was sized to provide the amount of power required for the RPA to takeoff using both the power provided by the IC engine and EM. This mode is referred to as dual mode.

2.5.3. Cruise

Once the aircraft has taken off and climbed to altitude, it cruises to the area of interest where it will loiter. Greiser [24] suggested that the cruise mode be accomplished with only the ICE. Since fossil fuels are more energy dense than battery power, and since noise is primarily a consideration in loiter mode, cruising in ICE only mode is the most efficient. The IC engine is sized for optimal performance in cruise mode. Mengistu [25] recommended that a Honda GX25 or similarly sized engine be used for the HEPS of an optimal HE-RPA capable of long loiter and quiet operation.

If a shorter time to the loiter location is desired, then cruise can be accomplished in dual mode. This quick cruise mode trades loiter time over the target area for a shorter travel time to the target area.

2.5.4. Endurance/Loiter

Based on currently fielded SUAS, the quietest way for the RPA to loiter is to loiter using the EM only mode. Rotramel [14] suggested that an optimal solution would include an efficient electric motor that is just powerful enough to provide the minimum torque required during loiter mode. Rotramel [14] further stated that, “Operating at

maximum efficiency will require less current from the batteries and therefore result in increased endurance.”

2.5.5. Regeneration/Recharge

Although a persistent loiter mode is ideal, eventually the batteries will run low and additional loiter time is not possible without recharging the batteries. With regeneration capabilities, the HE-RPA could go to an area where a higher acoustic signature is acceptable and operate in ICE only mode while recharging the batteries. This capability supports a mission where the HE-RPA only needs to operate quietly during segments of the flight. Any time during the mission profile when the HE-RPA is in cruise mode, it can also be in regeneration mode. With regeneration capabilities, the total loiter time of the aircraft is extended beyond the capabilities of one cycle of the battery charge.

2.5.6. Land

The HE-RPA is capable of landing using the IC engine, EM, or both. By having an HEPS system, there is a redundant landing system. When flying the RPA powered by an IC engine only, the IC engine was usually turned off just before the aircraft touched the ground. The HEPS system improves the probability of a recoverable landing by including the EM. In the event of an unfavorable landing situation that arises after the ICE is disabled, the EM could be used to power the RPA for another landing approach.

2.6. Power Sources

2.6.1. Photovoltaic Cells

Koster [22] argued that photovoltaic cells can provide enough power to offset their own weight but do not add any additional net power. Based on this analysis, it was determined in the analysis of alternatives that photovoltaic cells would not be used for the HEPS developed in this research.

2.6.2. HEPS

Rotramel [14] researched different commercially available power sources and used an optimization routine to determine the optimal ICE, EM, and propeller for use on the AFIT HEPS. Ausserer [12] researched the commercially available batteries and determined that Lithium Polymer (Li-Po) batteries would be the best batteries to power the EM and avionics system of the AFIT HEPS.

2.7. AFIT Aircraft Design

The conceptual design for the airframe was generated by Harmon [6] and the actual design and build was completed by CLMax [26] and designated as the Condor. Using an optimization routine, Harmon found that a large, high aspect ratio wing would be best, while still taking into account other requirements such as structure, weight, and low-observability. The Condor was designed to have a high lift to drag ratio and be shaped similar to a glider to facilitate long loiter operation. Giacomo [13] outlined the specific dimensions and flight characteristics of the Condor in his thesis. By designing a

new airframe instead of integrating the HEPS into an existing airframe, the flight characteristics of the new airframe were tailored to the HE-RPA CONOPS.

Although the Condor was designed to leverage the capability of an HEPS, two airframes were built to support this project. The first version of the Condor, AFIT 1, was to be powered by a Honda GX35 ICE engine. The second version of the Condor, AFIT 2, was to have the HEPS with a Honda GX25 ICE engine and an AXI Motor. AFIT 1 acted as the control for the AFIT HE-RPA effort and acted as a baseline for comparing long loiter and near silent capabilities.

2.8. Acoustic Measurements and Propellers

Almost all RPAs currently employed throughout the world rely on a propeller and propulsion system to generate the thrust necessary for flight. Propellers, however, contribute significantly to the overall acoustic signature of any propeller driven aircraft. Numerous studies are underway in an attempt to characterize and design quieter propellers, primarily for use in congested or covert locations. Research by Burger [27] resulted in a model capable of predicting the performance of specific propeller design; however, it was still immature and needed additional validation. In lieu of a predictive tool, acoustic testing of propellers and RPAs in-flight is currently the alternative used to evaluate acoustic performance. Testing conducted by Gregorek and Korkan [28] concluded that propeller acoustic noise is a function of propeller loading and diameter; with lightly loaded propellers with smaller diameters yielding a substantial decrease in noise.

In regards to propulsion system noise, research by Fidler [29] found that the acoustic signatures of comparative ICEs and electric motors were dependent on the throttle setting. At lower throttle settings, the difference between an ICE and an electric motor was smaller than at increased throttle settings. Additional testing with the Silver Fox RPA also yielded specific information about the acoustic signature of small RPAs with ICEs [30]. In general, the Silver Fox testing validated common employment tactics and design for reduced RPA detection.

2.9. Tailored Systems Engineering Process

In light of the aggressive scope and limited timeframe of the current research, the HE-RPA development team determined early in the development process, that it would not be feasible to accomplish all of the systems engineering activities prescribed by the Department of Defense SE guide [31] which encompasses commonly accepted SE practices. However, the team agreed that a tailored systems engineering process would be used to assist in accomplishing research objectives.

The team determined that establishing and following a tailored systems engineering process would assist in accomplishing research objectives by maintaining a level of systems engineering discipline throughout the research effort. Humphreys et al. [32] successfully applied a tailored systems engineering process to the development of a ground hardness technology demonstrator. The tailored SE process established by Humphreys et al. [32] focused on requirements management, where requirements were defined early in the systems engineering process and tracked throughout the development

of the system. Humphreys et al. [32] did not initially plan on following the systems engineering V-Model but did eventually use it and found it to be helpful.

Additionally, Abbott et al [33] applied a tailored systems engineering process to the development of the fleeting target technology demonstrator, which included a functional area analysis, functional needs analysis, functional solutions analysis, measures of effectiveness, measures of performance criteria, an integrated architecture, a concept of operations with expanded scenario development, a risk assessment and analysis with risk mitigation strategies and a system level test plan to address risk areas. The framework of a tailored SE process, developed by Abbot et al [33], was designed for use by all programs with a rapid transition from the lab to the program office.

2.10. Summary

This chapter provided a brief overview of the current state of the development of HE-RPA's and their potential to fill a capability gap of long loiter and quiet operation in a military environment. This chapter also discussed the potential of using a tailored SE process to aid in the rapid development of an RPA that would fill the existing capability gap. Following is the methodology that guides the remaining HE-RPA development effort.

III. Methodology

3.1. Chapter Overview

This chapter examines a methodology and process for evaluating the hybrid-electric RPA as a viable concept to fill the identified capability gap and achieve the capabilities detailed in the CONOPS (Appendix A). The chapter mirrors a systems engineering plan (SEP) operational requirements, a system level architecture, system development and integration, risk management planning, and development of a test and evaluation master plan (TEMP), Appendix K.

3.2. Operational Requirements

Previously, Chapter II detailed the need for a tactical, flexible and multi-modal (ICE and EM) ISR RPA system with greater endurance than what was currently available in battery-powered systems. Specific requirements were identified via the Joint and USAF UAS future and vision statements cited previously, along with preliminary discussions with the Air Force Research Laboratory's (AFRL) Center for Rapid Product Development (CRPD). The following requirements are a synopsis of desired capabilities and operational needs currently lacking or deemed insufficient in operational RPA systems currently available.

- *Rapidly setup and deploy RPA system from austere location*
- *Quickly ingress/egress to/from the target area utilizing internal combustion engine*
- *Covertly loiter over a desired target area using electric power*

- *Utilize payloads suited for low altitude operations*
- *Monitor ISR data from safe standoff distance*
- *Regenerate electrical stores for sustained surveillance operations*
- *Provide timely ISR data for ongoing/future ground operations*

These requirements were directly linked to the HE-RPA concept within the CONOPS, whereas the generated systems architecture attempted to capture the higher level, overarching, requirements of operational users and stakeholders.

3.2.1. Concept of Operations

High level operational needs are captured within the CONOPS. In particular, Harmon and Hiserote [20] envisioned a segmented ISR mission profile in order to provide near-silent electric RPA operations, yet retain the benefits of an ICE powered RPA. The segmented ISR profile is captured within the CONOPS. The CONOPS details a set of operational capabilities desired by potential users employing a HE-RPA. The CONOPS sets the stage for an architectural framework aimed at delivering the overarching capabilities desired by the user.

3.3. Systems Architecture

The purpose of the systems architecture was to create a foundation from which system development could begin. Additionally, the foundation of the tailored SE approach utilized herein is a systems architecture depicting both an “as-intended” configuration along with an “as-built” configuration. From inception, it was well

understood that achieving a system delivering the envisioned capabilities would be infeasible given the realistic schedule and budget constraints. The authors took a two pronged approach in order to capture and analyze this departure; 1) development of dual systems architecture, an “as-intended” and “as-built” variation, and 2) an analysis and evaluation of the known and identified capability gaps. The “as-built” variation covered aspects of the system that were reasonably believed achievable within the given constraints of the effort, and the “as-intended” variation detailed the envisioned system in a fully operational configuration. Deviations between the “as-built” and the “as-intended” concepts were captured within additional architecture products, i.e. the Systems View 8 (SV-8). All systems architecture products were in concordance with the Department of Defense Architecture Framework (DoDAF) Version 2.0.

While the CONOPS captured the full range of capabilities and intended usage of an HE-RPA, it was observed by the authors that the critical capabilities identified in the CONOPS below (with the exception of multi-mode operation) were not necessarily specific to a HE-RPA platform.

Critical Capabilities from HE-RPA CONOPS

- *Austere Employment Capability*
- *Rapid Ingress and Egress Capability*
- *Sustained Near-Silent Loiter Capability*
- *Effective Multi-Mode Operation*
- *Minimally Complex Operator Interface*
- *Adaptable ISR Payload Capability*

Based on these critical capabilities identified within the CONOPS, it was decided that the systems architecture would focus on the overarching capabilities and the desired end state rather than a more detailed system/functional architecture. This sets the architecting scope for this effort. In some instances, it was useful to include specific aspects of the HE-RPA CONOPS within the architectural products in order to facilitate a comparison between the “as-intended” and “as-built” configurations. Detailed information on HE-RPA system functionality and system interactions (physical architecture) can be found in Ausserer [12] and Giacomo [13].

Coinciding with the tailored systems engineering approach, it was decided that only architecture products providing decisive information (fit-for-purpose) would be produced. Figure 3, illustrates the selected architecture products and their relations and interactions with one another. The diagram also distinguishes between the “as-intended” and “as-built” configurations of the HE-RPA, which are addressed in more detail later in this chapter. The development of a succinct architecture was viewed as critical to the

development of the HE-RPA as a potential part of the larger military ISR capability. It was anticipated that time spent on architecture development early in the HE-RPA development process would save time later in the project by focusing efforts and limiting the scope of the total project.

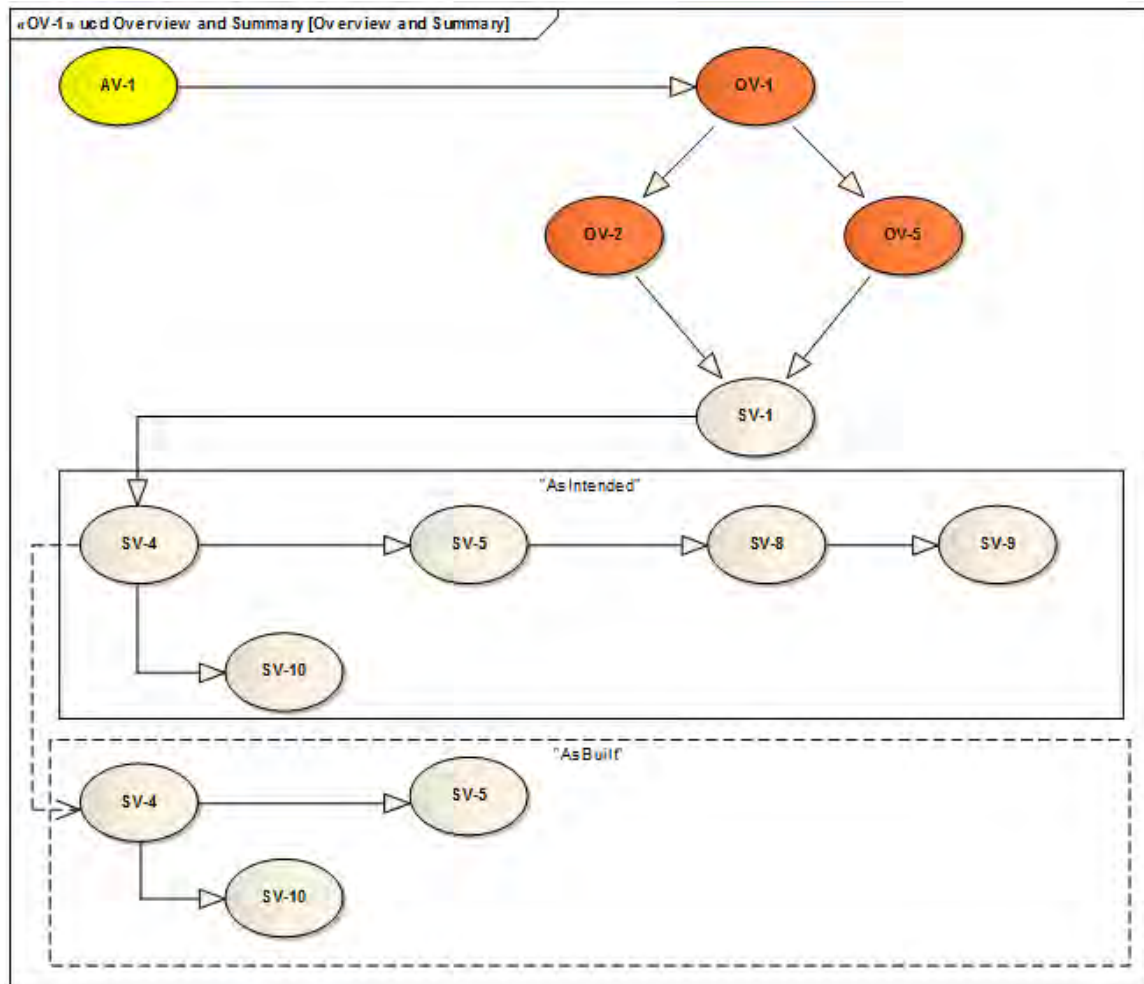

Figure 3: Systems Architecture Products; DoDAF version 2.0

3.3.1. All Viewpoints

The All Viewpoints of the DoDAF provide information that pertains to the entire architectural description. In particular, the All View 1 (AV-1) provides executive level summary information and provides the framework for the architecting effort. The AV-1 for the HE-RPA documented this effort's vision, objectives, goals, plans, activities, events, conditions, measures, and effects. Additionally, the AV-1 served as a planning guide for the entire effort. The AV-1 also details the purpose of the architecture, which is to provide a blueprint for vehicle development, gap analysis, and testing. The complete HE-RPA AV-1 is included as Appendix B.

3.3.2. Operational Viewpoints (OV)

The Operational Viewpoints were utilized in the HE-RPA architecture as a means to describe the tasks, activities, operational elements, and resource flows needed to realize the envisioned operational capabilities. The envisioned operational capabilities were captured within an operational scenario realizing the benefits of an HE-RPA. The scenario encapsulated many of the operational requirements collected and detailed previously in Chapter II. This scenario was the foundation for architectural development. A high-level graphic description of this scenario was also depicted in the Operational Viewpoint 1 (OV-1) Figure 4, which is discussed in greater detail in the CONOPS.

The operational scenario envisions a military ground unit, with intelligence indicating a possible increase of insurgent activity in a nearby township, deciding to evaluate the situation before proceeding with intervening actions. In this situation, high-value low-density assets (Satellite imagery, Global Hawk, or Predator RPA) are

unavailable. Gasoline/diesel powered RPAs are noisy and may alert the insurgents that they are being observed, but the quieter electric-powered RPAs lack the range necessary to both ingress to and egress from the target area to collect ISR data. From a safe, yet austere, undetectable distance, the hybrid-electric RPA can be quickly setup and deployed, flown to the area of interest, loiter and collect ISR with near-silent operation and relayed ISR data back to a ground station or field unit, regenerate battery capacity if prolonged near-silent operation is required, and then returned for redeployment.

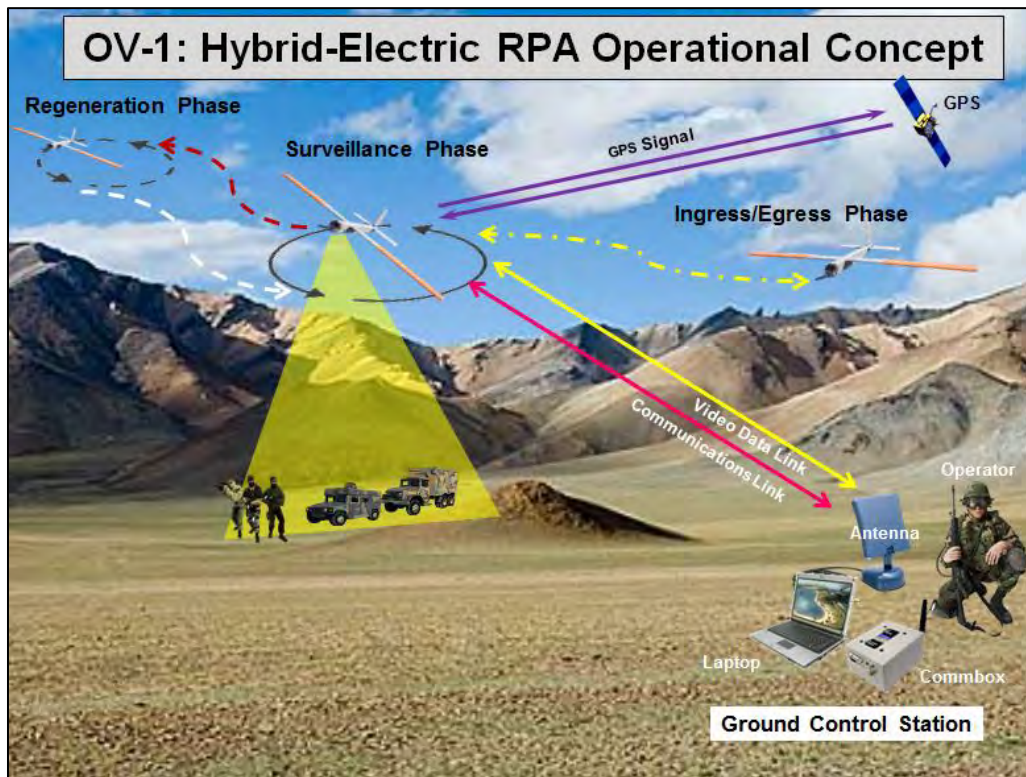

Figure 4: Hybrid-Electric RPA Operational View (OV-1)

The architecture for the HE-RPA was required to capture the flow of information and material between the different operational activities or operational nodes required to

support the capabilities identified in the CONOPS. The Operational View 2 (OV-2) captured these flows as needlines within the diagram, see Figure 5.

As envisioned within the CONOPS, the RPA represented one of the operational nodes, encompassing multiple activities. It was clear from the OV-2 that there was a heavy dependence on RPA control information and ISR data between the operator node and the RPA node via the ground station node. The operator node was also the means by which the RPA's activities are translated into useful products and information back to other operational nodes or stakeholders, of the system. The OV-2 began to lay the foundation for identifying the required system functionality and detailed activities necessary for the HE-RPA system. The only HE-RPA specific information flow depicted was the HE-RPA mode control.

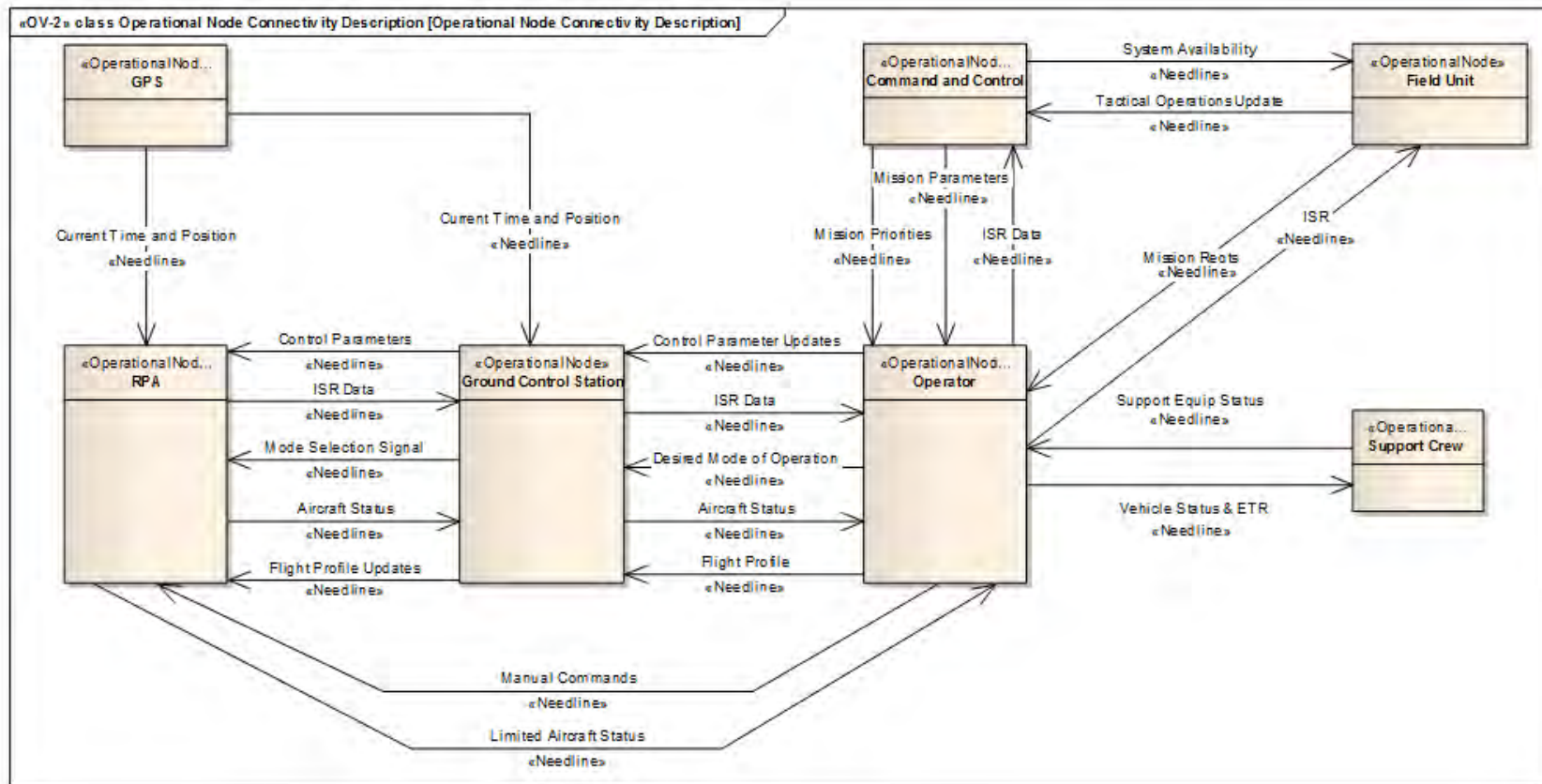

Figure 5: Hybrid-Electric RPA OV-2

Almost all RPA missions are currently centered on the collection and dissemination of ISR data. In order to provide this data via the use of an RPA, the system requires a specific set of activities. These activities are captured as use cases and indicate what actions need to be accomplished and by whom or what aspect of the system. An operational activity model, also referred to as a use case model, captures these interactions. A use case diagram capturing the activities and relationships depicted in the CONOPS is shown in Figure 6.

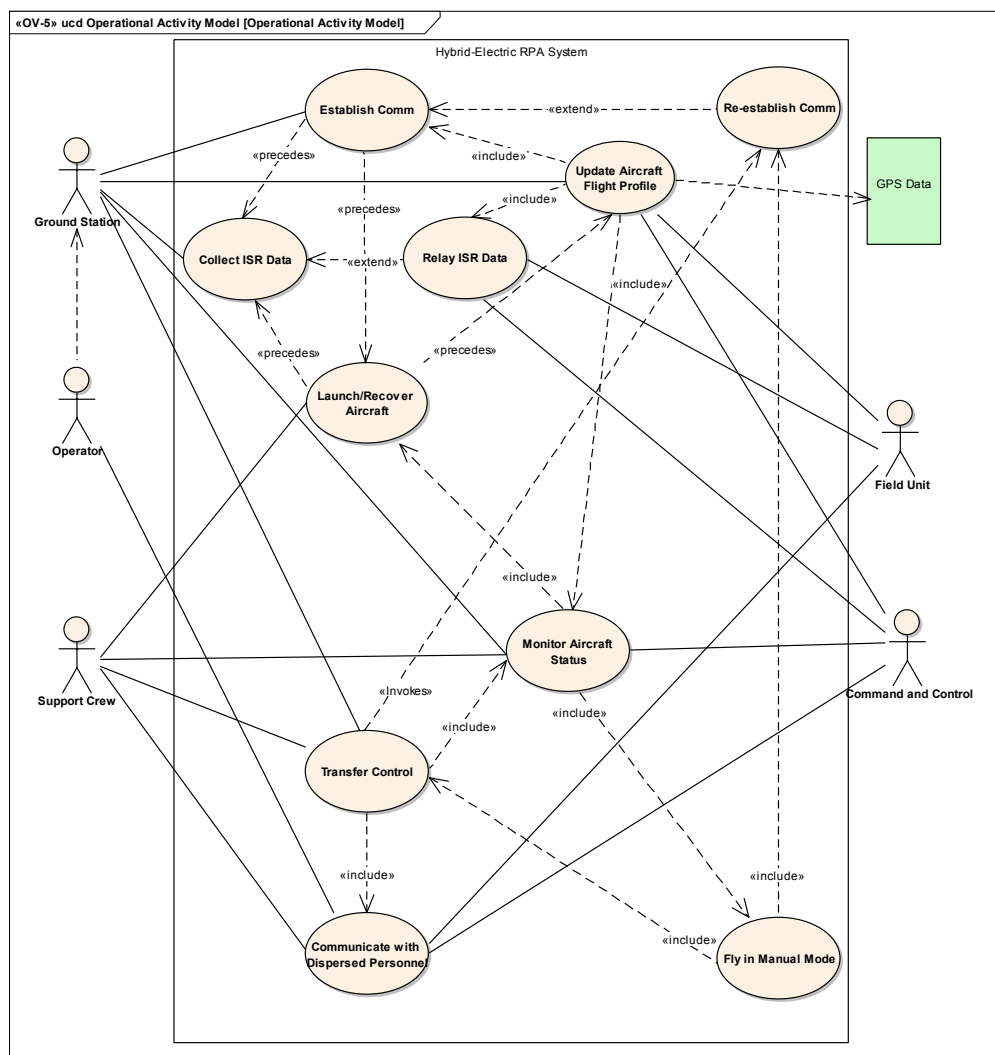

Figure 6: Operational Activity Model (Use Case Diagram)

The activities depicted in the use case diagram are generally at a high level in relation to individual tasks or operations. Subsequently, the lower level actions are captured in textual use cases, which can then in-turn be used to generate activity diagrams to isolate specific actions that must be performed by the system. The textual use cases and activity diagrams for this effort are captured in Appendix C. The activities are also captured and are utilized in the SV-5 diagram.

Of note in the use case diagram presented above, the primary objective of the scenario is to provide ISR data to the field units and Command and Control actors. The collect ISR use case is left generic, indicating that the capability could potentially be provided via numerous alternatives. The HE-RPA is not necessarily a forgone conclusion. The remaining use cases such as, Establish Comm, Monitor Aircraft Status, Transfer Control, etcetera, and the associated actors are currently standard for traditional RPAs. The trade space for alternative solutions other than an RPA solution has been reduced. The remaining systems engineering activities focus on evaluating an RPA system as a viable solution to fill the identified capability gap.

3.3.3. Systems Viewpoints (SV)

After identifying the operational requirements of a system via the operational viewpoints, the Systems Viewpoints (SVs) are a means to describe systems and interconnections linking system resources to the operational requirements. Beginning with the established framework associated with an RPA system and operational activities previously captured by the OV-2 and OV-5, the Systems Viewpoint 1 (SV-1) allows

interconnections of the necessary system elements to be identified. The following system components, including human components, were identified for the HE-RPA system.

- Aircraft (the HE-RPA)
- Ground Control Station
- Operator
- Command and Control
- Manual Backup
- Global Positioning Satellite (GPS)
- Environment
- Support Crew
- Field Unit

The SV-1 shown in Figure 7 identifies the interactions and sharing of resources between elements of the RPA system. Attributes of the RPA and GCS elements are shown in order to identify where the HE system capabilities reside, even though they are not prescribed by DoDAF for an SV-1.

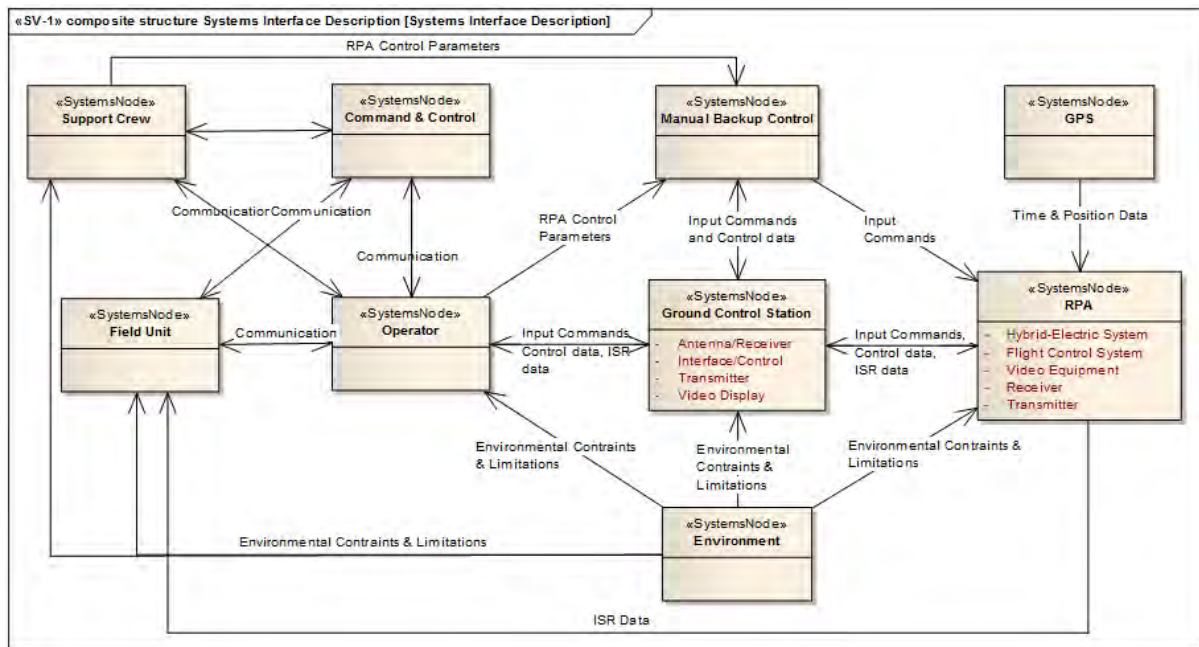

Figure 7: System Interface Description (SV-1)

A substantial take away from the SV-1 is the inherent responsibility that falls on the operator and GCS elements. Regardless of the HE aspect of the system, it is the operator and GCS element that link the field unit element back to the RPA element. The SV-1 provides a stable location within the architecture where operational requirements and system resources merge, ensuring that operational requirements remain traceable throughout system development. The SV-1 also indicates how the system may be potentially structured due to the system resource flows between the elements. The SV-1 is a starting point from which to evaluate the “as-intended” and “as-built” variations of the systems level architecture.

The SV-4, systems functionality description, details the necessary functions and behaviors that the RPA system must perform in order to provide the desired capabilities. Specific system functions of the HE-RPA were added to the SV-4 in order to later identify relationships with the operational activities. The SV-4 diagrams capture the deviations between the “as-intended” and “as-built” variations of the architecture. As an example, the SV-4 diagrams for the “*Provide Covert ISR*” function, shown in Figure 8 and Figure 9, identifies, via the red nodes, that the “as-built” configuration will lack functionality to *operate in low light* and to *optimize a flight profile*. Successful development and testing of the “as-built” configuration becomes more likely with the reduced functionality. Additionally, future development efforts have a clear understanding of what was and was not accomplished by prior efforts. A complete set of SV-4 diagrams and the identified functionality gaps between the “as-intended” and “as-built” configurations is shown in Appendix D.

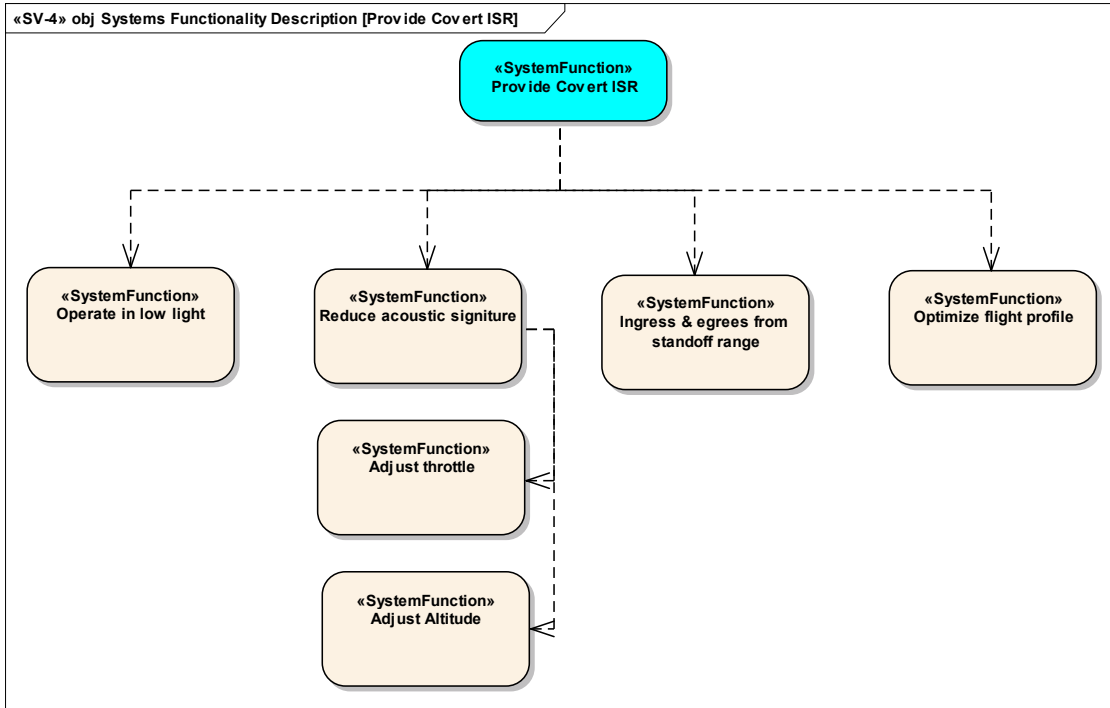

Figure 8: SV-4, Provide Covert ISR “as-intended”

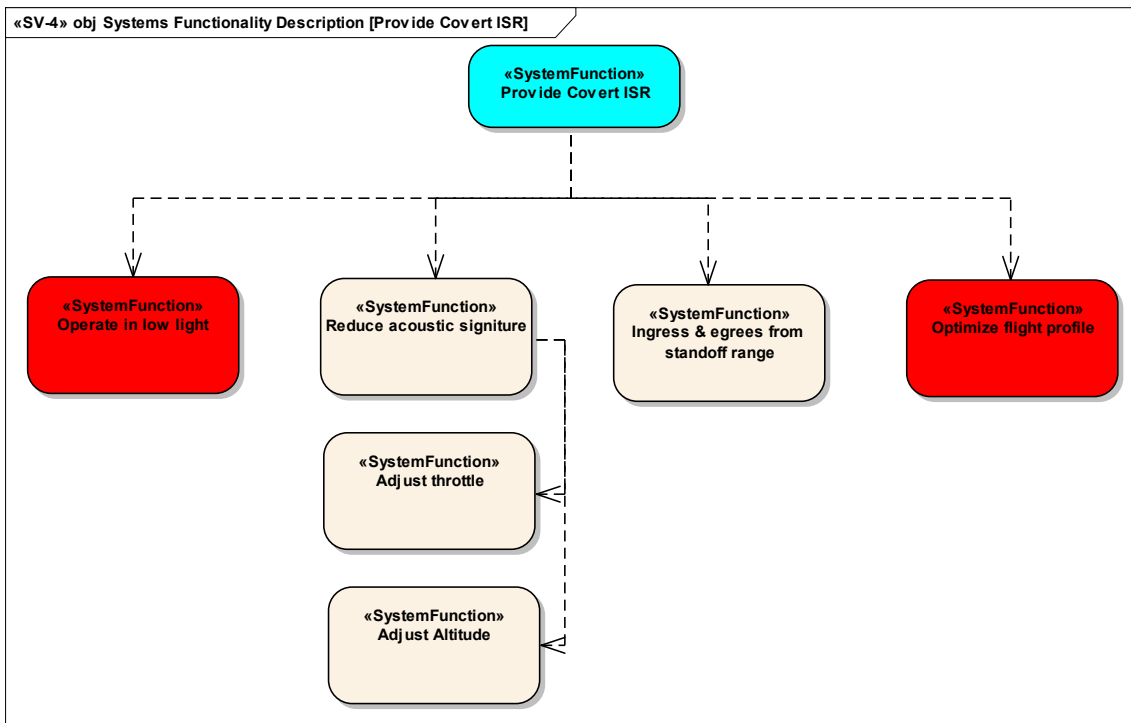

Figure 9: SV-4, Provide Covert ISR “as-built”

As a summary for the SV-4, the following functions shown in Table 2 were prescribed for the “as-intended” variation but removed from the “as-built” variation. These functions were knowingly removed from the development effort and they become documented gaps for future efforts. The remaining functions for the “as-built” configuration now become the focus of the development effort and the focus of Ausserer [12] and Giacomo [13].

Table 2: Functions Removed from "as-intended" Configuration

Functions Removed From the "as-intended" Configuration	
Operate in Low Light	Maintain Airframe Integrity
Optimize Flight Profile	ATV Transportable
Monitor ISR Sensor Status	Launch and Recover on Un-improved Surfaces
Follow Moving Target	Identify Targets
Maintain Contact with Target	

Although, the SV-4 diagrams identify functionality gaps between the “as-intended” and “as-built” configurations; that does not necessarily translate into capability gaps. The SV-5 captures relationships between system functions and activities to truly identify if a capability gap exists.

The SV-5 identifies relationships between the operational activities depicted in the OV-5 and the system functions captured by the SV-4. The purpose is to ensure that all system functions are traced back to an operational requirement or vice versa. Functions that do not trace back to operational requirements indicate additional capabilities or features that were not originally desired or are in excess of what is required. Operational activities that do not correspond to a system function indicate a capability gap.

The SV-5 matrices generated for this effort are captured in Appendix E. Two different variations were generated in order to capture deviations between the “as-intended” and “as-built” variations of the architecture. The operational activities utilized to generate the SV-5 were independent of the pre-conceived HE-RPA system; however, functions associated with the HE-RPA were included. The intent was to determine if any of the HE-RPA specific functions, for both the “as-intended” and “as-built” configurations, are traceable back to a set of standard RPA operational activities.

Findings from the SV-5 indicate that both the “as-intended” and “as-built” configurations of the HE-RPA possess functionality that is not necessarily traceable back to the operational activities associated with standard RPA activities. Within the SV-5, functions highlighted in red indicate no traceability back to the operational activities. Incidentally, these functions in red are also specific and needed for by the HE-RPA to increase endurance. Functions highlighted in yellow indicate weak traceability back to the operational requirements, generally two or less activities. These weakly related functions, summarized in Table 3, may become good candidates if system tradeoffs become necessary in future development efforts.

Table 3: Weakly Related System Functions

System Functions	HE-RPA Only
Convert Power	
Utilize Common Fuel	
Utilize Common Tools	
Rapid Airframe Assembly	
Rapid Deployment & Recovery	
Intuitive Construction	
Minimize Fuel Consumption	
Spin Generator	X
Store Electrical Power	X
Generate Electricity	X
Interrupt Electrical Power Distribution	X

The SV-5 captures areas in which the “as-built” configuration would have reduced capability compared to the “as-intended” configuration. By looking at the activities affected by excluding functions from the “as-built” configuration, it becomes obvious that there will be a substantial deviation from a fully capable system. A list of the impacted activities is presented in Table 4. Although several activities are affected, no complete capability gaps were identified. However, the reduced capabilities of the “as-built” configuration would likely be unacceptable to a user or operator.

Table 4: Reduced Capability "as-built" Configuration

Reduced Capability for "as-built" Configuration	
Fly in Manual Mode	Monitor Aircraft Status
Establish Comm	Operator Initiates Recovery
Adjust Flight Profile	Operator Receives & Analyze ISR Data
Collect ISR Data	Process RPA Updates
Command and Control Acknowledgment of Aessage Receipt	Provide Mission Updates
Command and Control Evaluates ISR and Battlespace	Re-establish Comm
Command and Control Generates and Sends Update Request	Receive RPA Status Update
Command and Control Receive & Analyze ISR Data	Relay ISR Data
Communicate with Dispersed Personnel	RPA Broadcasts Signal
Confirm ISR Data Sufficient	RPA Encrypts ISR Data
Field Unit Evaluates ISR	RPA Processes Signals
Field Unit Receive & Analyze ISR Data	RPA Transmits Status
Field Unit Generates and Sends Update Request	Support Crew Activates RPA
Launch/Recover Aircraft	Support Crew Initiates Recovery
Maintain RPA Flight Profile	Support Crew Launches RPA

In order to progress from the “as-built” configuration to the “as-intended” configuration, a high level mapping of required effort was created and captured in the Systems Evolution Diagram in service viewpoint 8 (SV-8). The SV-8 is presented in Appendix F. This diagram not only illustrates remaining effort expected to achieve the

“as-intended” configuration, but it was created early in this effort and guided development of the “as-built” configuration. Although Appendix F is a large diagram, the page split represents the current status of this effort. As shown, the remaining efforts would likely focus on system analysis and refinement, production, and operational verification. Coinciding with the planning of future development efforts, the SV-9 (Technology & Skills Forecast) could be used to identify emerging or existing technology and skill that would aid in realizing the “as-intended” configuration. An SV-9 is presented in Appendix G. Continued development of the “as-intended” configuration may benefit from emerging battery technology, RPA microcontrollers, and RPA construction materials as indicated by the SV-9.

Although the systems architecture establishes a roadmap for the development effort, realization of the HE-RPA system still requires robust systems engineering and planning. The next section discusses the rationale and methods used for the remainder of this effort.

3.4. Early Systems Engineering and Planning

The initial step of any well planned systems engineering effort should be the identification and definition of project requirements and objectives; including establishing systems architecture. For this effort, the overarching requirements and objectives were the collection of sufficient information to inform a decision maker on future development potential. After requirements and objectives had been identified, technical requirements developed via the systems architecture and operational

requirements were developed in conjunction with the associated planning efforts needed to evaluate technical requirements.

In conjunction with the previously stated research objectives, this effort's emphasis was on concept evaluation of a HE-RPA and the desire to answer pertinent questions needed to make a decision on pursuing further system development and potentially initiating an acquisition program. The following questions, captured in the All-View 1 (AV-1) of the systems architecture, were a focus of the systems engineering effort.

- What additional efforts are needed to get to the “as intended” configuration?
- What are the technology gaps?
- How effective will it be?
- Will it provide military utility?
- Who are the users and stakeholders?
- Where could this concept be used successfully?

In order to answer these questions within the inherent time, budget, and schedule constraints, an approach examining only the necessary and value-added components of the traditional SE approach and DoD acquisition process was planned. Rationale for the selection and utilization of specific systems engineering and DoD acquisition components is discussed below.

3.5. Tailored Systems Engineering Approach

In order to gather the information needed to answer the previously posed questions and to address research objectives, a tailored SE approach was proposed. As the scope of the effort was limited to the evaluation of a prototype HE-RPA, the SE efforts focused on pre-systems acquisition events. The Defense Acquisition Guidebook (DAG) [34] provides a framework that allows acquisition professionals to develop and procure systems for the Defense Department in accordance with DoD directives. The DAG addresses these pre-acquisition events within the Defense Acquisition Management System depicted in Figure 10. The pre-systems acquisition phase includes materiel solution analysis and technology development; however, the vast majority of this effort was centered on the technology development phase. The equivalent of a materiel development decision for this project was essentially concluded via a previous decision to explore the HE-RPA concept as a materiel solution versus alternate doctrine, organization, training, material, leadership, personnel, or facilities (DOTMLPF) solutions [35].

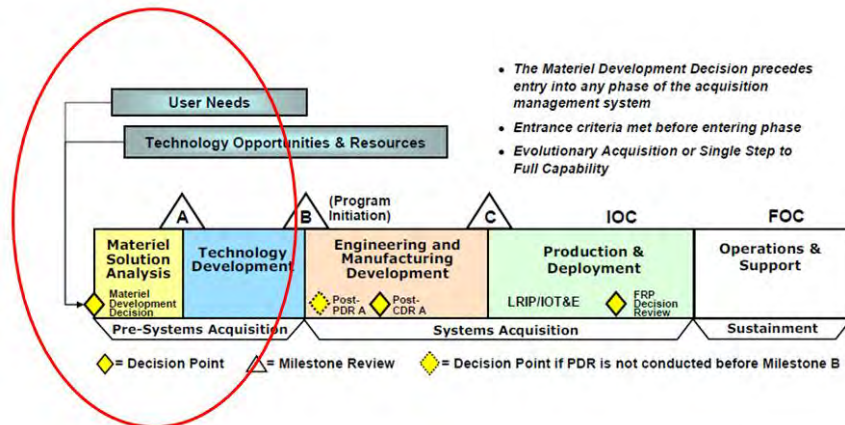

Figure 10: Defense Acquisition Management System

Narrowing the scope to essentially the technology development phase was a key aspect of utilizing a tailored systems engineering approach to perform the concept evaluation of the HE-RPA within a compressed development cycle. The inherent constraints of the technology development phase limited the scope of this effort to the development and demonstration of a prototype system, which was consistent with the previously mentioned limitations of this effort. The HE-RPA was considered an emerging technology and had not yet been successfully demonstrated [12], making a comparative analysis to other HE-RPA technology difficult. A key component of the concept evaluation was to determine the potential performance improvements resulting from inclusion of the HEPS over a baseline configuration. Therefore, a component of the systems engineering approach was to include the development and baseline evaluation of an RPA powered by an ICE propulsion system. All aspects of the tailored SE process were therefore needed to account for two airframes; airframe 1 (ICE powered) and airframe 2 (HE powered).

Although tailored for the evaluation of the HE-RPA, the selected approach still encompasses most of the elements associated with robust systems engineering. These elements were represented by the systems engineering V-model depicted below in Figure 11.

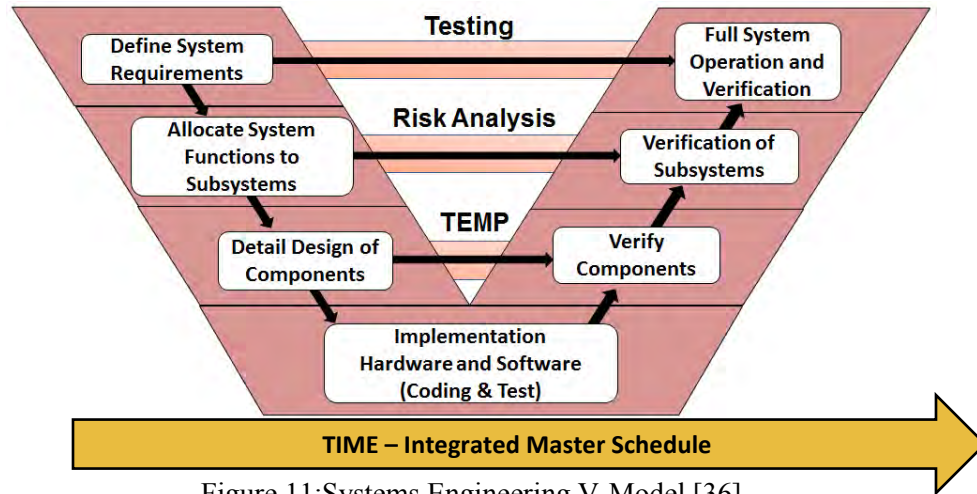

Figure 11: Systems Engineering V-Model [36]

The tailored SE approach leverages previous HE-RPA conceptual studies [10, 11, 20] to create a CONOPS, and the generation of systems architecture to define system requirements and to allocate system functions to subsystems. This approach also utilizes a team concept somewhat resembling an integrated product team. Team members included the authors, along with Ausserer [12] and Giacomo [13]; contributing to development of the HE propulsion system and airframe characterization, respectively.

At project initiation, the HE-RPA development team decided to use the following SE principles as the foundation of the tailored SE process used in this research.

- *Event driven*
- *Defined entry and exit criteria*
- *Value added*
- *Formal and informal format*

The HE-RPA development team also identified the following systems engineering activities as critical for the development of the HE-RPA and essential to the tailored SE process.

- *Preliminary design review*
- *Developmental test and evaluation*
- *DoD architecture framework*
- *Human factor/systems integration*
- *Critical design review*
- *Prototype/engineering development model*
- *Risk assessment*
- *System requirements review*
- *Systems engineering and technology development*
- *Test & evaluation master plan (TEMP)*
- *Test Readiness Review/ Safety review Board*

Early identification and solidification of primary research objectives and evaluation criteria/questions lead to the generation of measures of effectiveness (MOEs) and measures of performance (MOPs) for testing captured in the TEMP, Appendix K. Previous work conducted by Greiser [24], Rotramel [14], and Mengistu [25] along with concurrent work by Ausserer [12] were utilized and tracked via an evolving integrated master schedule (IMS) in order to establish a detailed design for the HEPS. The tailored

SE approach took advantage of previous work by Harmon et al [11, 20] and Hiserote [20], as well as ongoing efforts by Giacomo [13] for airframe design parameters for the HE-RPA. The component level designs were evaluated in order to identify only those performance characteristics and parameters that contributed to meeting the overarching research objectives and evaluation criteria.

The test planning and evaluation techniques of these objectives are addressed within the TEMP (Appendix K) and the evaluation section which follows later in Chapter III. As this effort was focused on the technology development phase with a prototype system, component and system verification utilized a build-up approach, incorporating three main levels of testing; functionality, safety, and performance. Functionality testing focused on basic system operation and is intended to verify system design and operation. The HE-RPA incorporated potentially hazardous systems; therefore, it was critical that the safety aspects of the system be vetted via the planned risk mitigation efforts and safety review boards. Ultimately, the performance of the HE-RPA needed to be characterized by the development team in order evaluate the concept. Therefore, ground testing and flight testing were conducted in order to collect sufficient information. Testing and evaluation results are discussed in detail in Chapter IV.

As mentioned previously, time was the primary constraint to this effort. Therefore, risk analysis and risk management strategies were implemented throughout, with utmost attention on schedule risk. Risk is further addressed later in this chapter, section 3.8.

A key aspect of evaluating the hybrid-electric RPA concept using a tailored SE process was following an event driven process focused on just the elements deemed necessary to evaluate the prototype system against the CONOPS. The generation of an initial IMS ensured all events were planned in a logical and sequential manner. The IMS was also critical to monitoring progress and managing risk.

3.6. Planned Schedule

The proposed IMS for the HE-RPA development project is shown in Figure 12 beginning with the preliminary design review and ending with the flight test of airframe 2 which was the HE-RPA. Figure 12 was developed prior to the preliminary design review and shows the initial expected duration for each task. Although Microsoft Project presents the schedule as if it were schedule driven, the schedule was actually event driven. Events that were dependent upon the completion of other events were not started until the events that they depended upon were completed.

As the HE-RPA was being developed in an academic environment, there were some hard deadlines such as AFIT graduation. The scope of the HE development project was adjusted as needed to accommodate these hard deadlines. With the proposed, schedule ending in September and the graduation date set for March 22 there was some room for schedule delays, such as poor weather, built into the schedule. At inception, the team understood that the risk of poor weather delaying taxi and flight test increased for each week that the project was delayed.

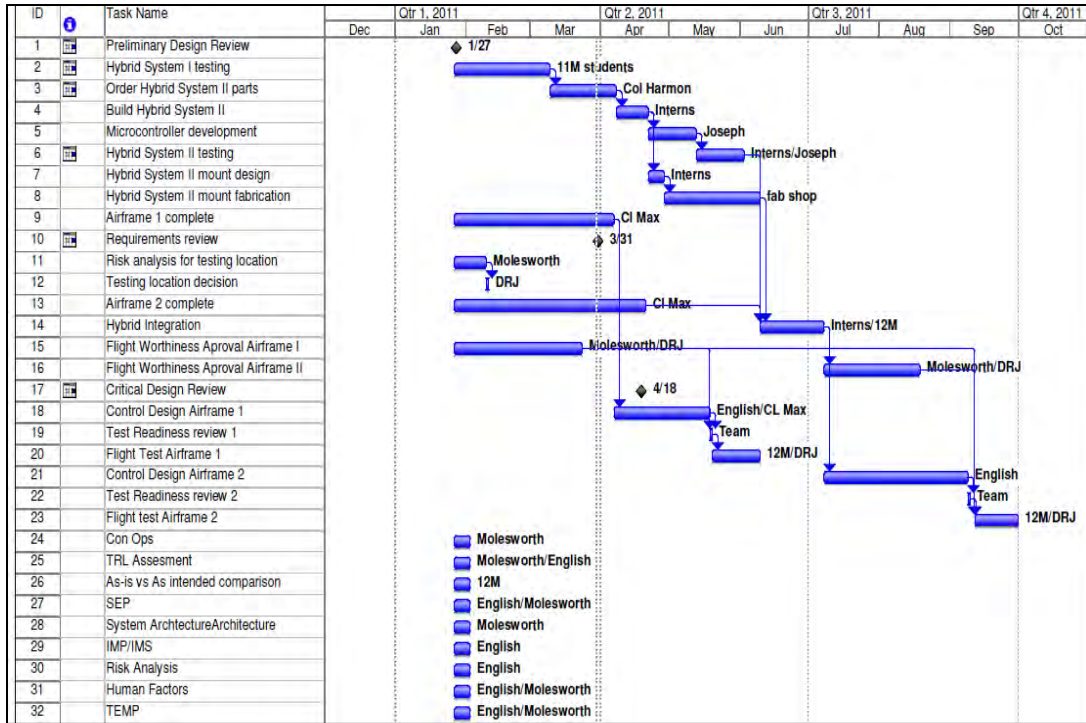

Figure 12: Planned HE-RPA Development IMS

The critical path was dominated by the development and integration of the HEPS. Any delay in the development and integration of the HEPS would result in a delay to the program. The current schedule shows a Hybrid System I and a Hybrid System II. Although only two iterations of the HE system were shown in the schedule, the possibility of requiring additional iterations in the development of the HE-RPA was considered. Wherever possible, extra components were to be ordered to allow for component failure and replacement during development.

According to the proposed schedule, the development of the airframes by CLMax was not on the critical path. Although the airframe development was not on the critical path, it was a task that was closely monitored by the authors because it was the task over which the HE-RPA development team had the least control. Some fabrication delay was

predicted as a probable event, and a lengthy delay was predicted as a possibility. If the delay were long enough, then the airframe development would have become part of the critical path. It was anticipated that lessons learned during the development and flight test of the airframes by CLMax would assist in the integration and flight test by the HE-RPA development team.

3.7. System Development

3.7.1. Prior Efforts

Research previously conducted by Harmon et al [10, 11, 20] and Hiserote [20] resulted in a conceptual design for a small (30 – 50 lb) hybrid-electric RPA. The HEPS design was based on a two-point design, which included an ICE sized for cruise speed (ingress/egress) as well as an electric motor and a battery pack sized for a slower endurance speed (loiter). This parallel HE design gave the vehicle longer time on station and greater range than electric-powered vehicles, in conjunction with smaller acoustic and thermal signatures than those currently used in gasoline-powered propulsion systems. A basic model of the parallel HE system is shown in Figure 13.

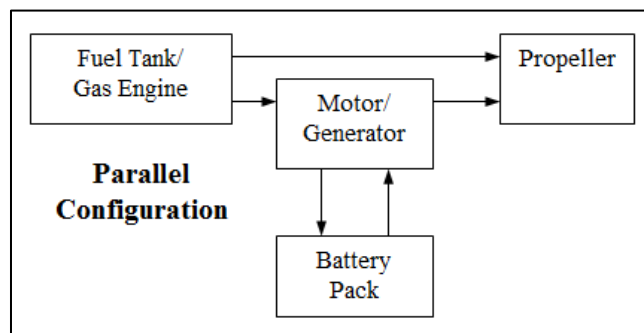

Figure 13: Conceptual Parallel Hybrid-Electric System

The prior research also produced the segmented ISR mission profile previously depicted in Figure 2. These efforts further resulted in the conceptual design for the airframe component of the HE-RPA. With a focus on the mission critical segment, endurance ISR collection, the resulting airframe design consisted of an airframe with a high aspect ratio wing, which minimized the power consumption and thrust required. The optimization efforts conducted by Harmon and Hiserote [20] yielded specific airframe design parameters, some of which are detailed in Figure 14. These conceptual efforts lead to the actual hybrid-electric propulsion system and airframe development discussed below.

Parameter	Value	Units
Wing Loading, W/S	90.00	N/m^2
Aspect Ratio, AR	14.42	-
Wing Planform Area, S	1.48	m^2
Wing Span, b	4.62	m
Wing Chord, c	0.321	m
Max Lift Coefficient, $C_{L,max}$	1.25	-
Stall Velocity, V_{stall}	11.84	m/s
Theoretical Endurance Velocity, $V_{endure,theor}$	9.27	m/s
Actual Endurance Velocity, $V_{endure,act}$	14.41	m/s

Figure 14: Optimized Airframe Design Parameters

3.7.2. Airframe Development & Procurement

As a prelude to the HE-RPA conceptual evaluation, the aforementioned airframe design parameters were utilized to provide a design specification to the contracted airframe developer, CLMax. Prior to any airframe component fabrication, an informal preliminary design review was held at AFIT to re-confirm design specifications and ensure the airframe's ability to accommodate the planned integration of the hybrid-

electric propulsion system. This meeting yielded the agreement to proceed with the fabrication of two airframes (one for the previously mentioned baseline analysis and the other for hybrid-electric integration). Details of bulkhead and fuselage configurations were also discussed, ensuring adequate room for the hybrid-electric system, fuel, batteries, and avionics. It was also agreed that a determination of the final wingspan, 12 ft or 15 ft, could be agreed upon at a later date. The preliminary allocation of components is detailed below in Figure 15.

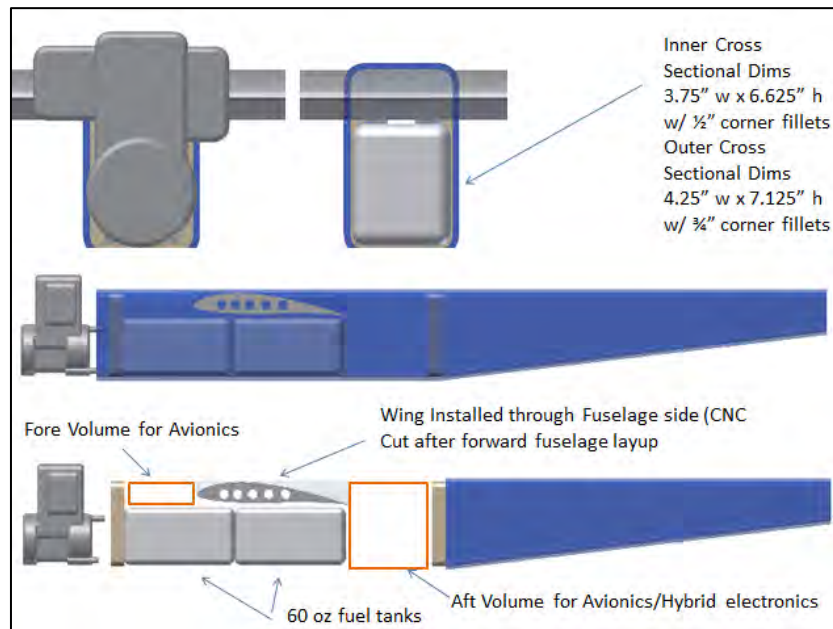

Figure 15: Preliminary Allocation of Airframe Components

Findings by Giacomo [13], indicated that the airframe design would have lateral stability issues at the optimized 15-ft (4.62 m noted above) wingspan configuration. To mitigate the potential risk associated with testing a marginally stable 15-ft wingspan, the development team determined that a 12-ft wingspan, capable of being re-configured to the 15-ft wingspan with two 18 inch wingtip extensions, was the preferred alternative.

The modular wing design would also enhance transportability of the airframe. The 12-ft configuration was also ideal as it would allow for testing to be conducted in a build-up manner and mitigate the risk associated with taxiing a high-aspect ratio wing.

Incremental updates and airframe fabrication status was also agreed upon. Photographs detailing intermediate fabrication steps are shown below in Figure 16 and Figure 17.



Figure 16: CLMax Wing Loading Tests (15-ft Wingspan)



Figure 17: CLMax Wing Load Testing

Coinciding with the airframe fabrication, an aircraft performance model was developed in order to generate the stability and control parameters needed in order to operate the HE-RPA under the planned autopilot control. A Matlab/Simulink model was created by Giacomo [13] in order to determine the appropriate range of proportional, integral, and derivative (PID) control values that were required by autopilot navigation and control systems. An overview of the aircraft's longitudinal control structure is shown in Figure 18. Verification of the model and the control values is included as the initial component of the baseline airframe (AFIT 1) evaluation and testing.

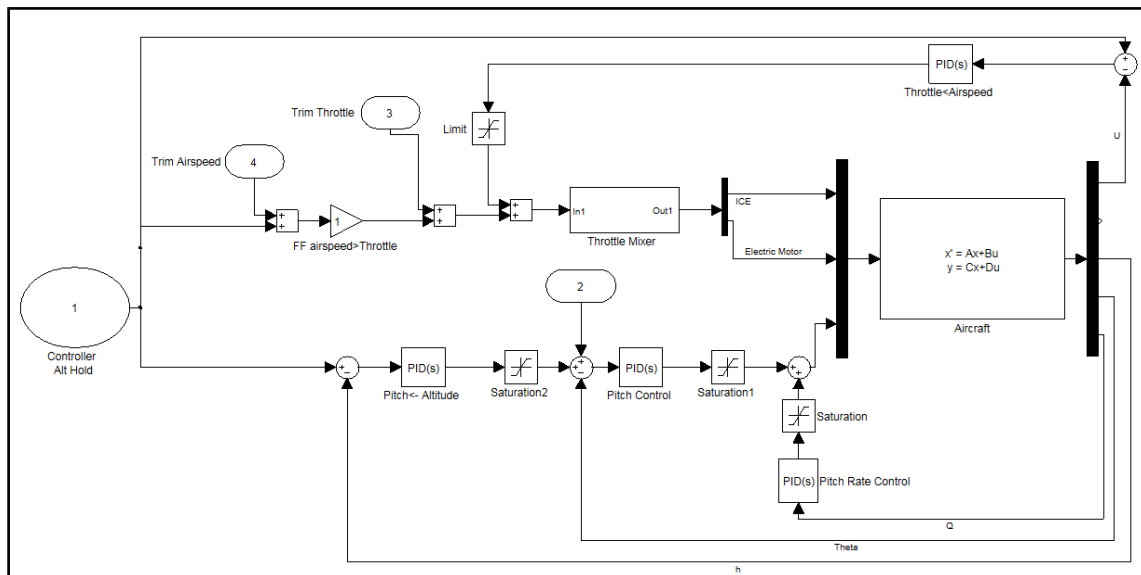

Figure 18: RPA Control Model

3.8. Risk Analysis

The proposed schedule shown in Figure 12 outlines three main objectives: develop and fly the Condor airframe, develop a suitable HEPS, and finally integrate the HEPS into the airframe and then fly the HE-RPA. If either of the first two events were not achieved, then the third event could not have been achieved. Each of the three events constituted a risky project in their own right. Due to the aggressive scope of the project

as a whole, a robust risk management plan including qualitative and quantitative risk analysis was required.

3.8.1. Qualitative risk analysis

A qualitative risk assessment was conducted by the HE-RPA development team during project initiation and is included as Appendix H. The identified risks were flight test approval, HE development/configuration, risk of crashing an airplane, further fabrication shop delays, feedback control, and improper propeller type. Under each risk is a description of the risk, a planned mitigation effort and an expected impact if the risk were to occur. Near project completion, the qualitative risks identified at project initiation were revisited and a results section for each risk was added.

3.8.2. Quantitative risk analysis

Due to the high level of uncertainty in the proposed schedule, there was also a degree of uncertainty regarding which tasks were on the critical path. If tasks initially on the critical path took less time to complete than expected, and events not on the critical path, such as airframe fabrication, took more time than expected, then they could have become part of the critical path. Nicholas and Steyn [37] recommend using a network diagram to illustrate a schedule and its tasks.

Activities A through O in Table 5 were selected as nodes for the network diagram shown in Figure 19. Each of the HE-RPA development team members were asked for a best guess at the minimum, likely, and maximum number of weeks that it would take to accomplish each task. The average likely duration was used to populate the duration of each task in the network diagram shown in Figure 19.

The following equations, outline by Nicholas and Steyn [37] were used to generate the other fields in the network diagram.

$$\text{Finish time} = \text{Start time} + \text{Duration} - 1$$

$$\text{Early Finish} = \text{Early start} + \text{Duration} - 1$$

$$\text{Late start} = \text{Late finish} - \text{Duration} + 1$$

$$\text{Total slack} = \text{Late start} - \text{Early start} = \text{Late finish} - \text{Early finish}$$

$$\text{Free slack for activity} = \text{Early start (earliest successor)} - \text{Early finish (activity)} - 1$$

Nicholas and Steyn [37] explained that the early start and finish represent the soonest that a task can be started or finished, while the late start and late finish represent the most that a task can be delayed before it further delays the critical path and the project as a whole.

Table 5: Network Diagram Activities

Activity	Description	Duration		
		min	likely	max
A	Build EM system	2.25	4	6
B	Build ICE system	2.75	4.125	7
C	Build Airframes	17	23.5	36.5
D	Bench test EM system	1.5	2.5	4
E	Bench test ICE system	1.5	3.25	8
F	Build HE system	4.75	7.25	14
G	Integrate AFIT 1	1.5	3	5
H	Bench test HE system	2.5	3.5	5.75
I	Taxi test AFIT 1	0.875	1.25	2.25
J	Integrate AFIT 2	1.5	3	5
K	Flight test AFIT 1	2.25	3.5	6.5
L	AFRL flight test approval	2	4.25	7
M	Bench test AFIT 2	1.25	2.75	4.25
N	Taxi test AFIT 2	0.875	1.5	2.75
O	Flight Test AFIT 2	1.75	3.5	6.75

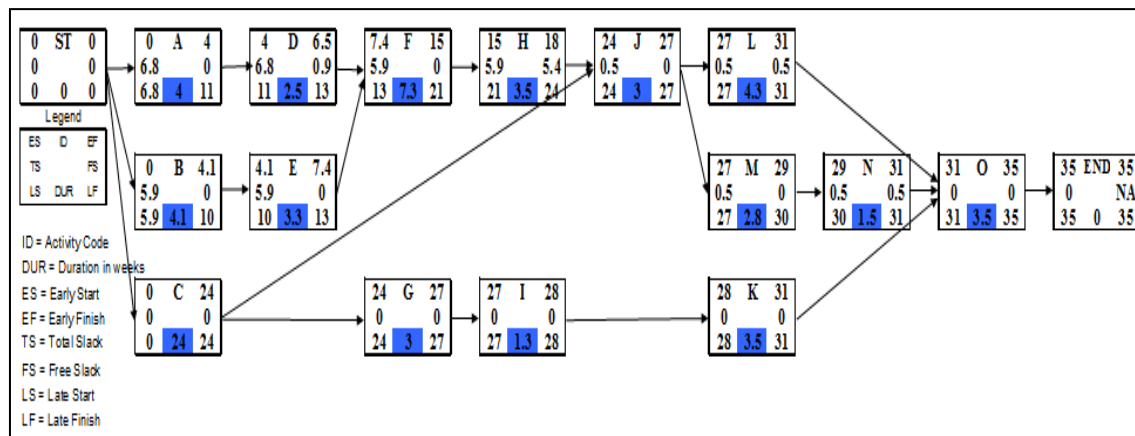

Figure 19: HE-RPA network calculations

Due to the high degree of uncertainty in the estimation of the minimum, likely, and max duration of each task, a Monte Carlo Simulation was used to generate 100 simulated passes through the network diagram. Each task was approximated by a triangle distribution. A random sample of each task was selected for each pass through the network diagram. The resulting durations of each pass were sorted into bins and the results are shown in Figure 20.

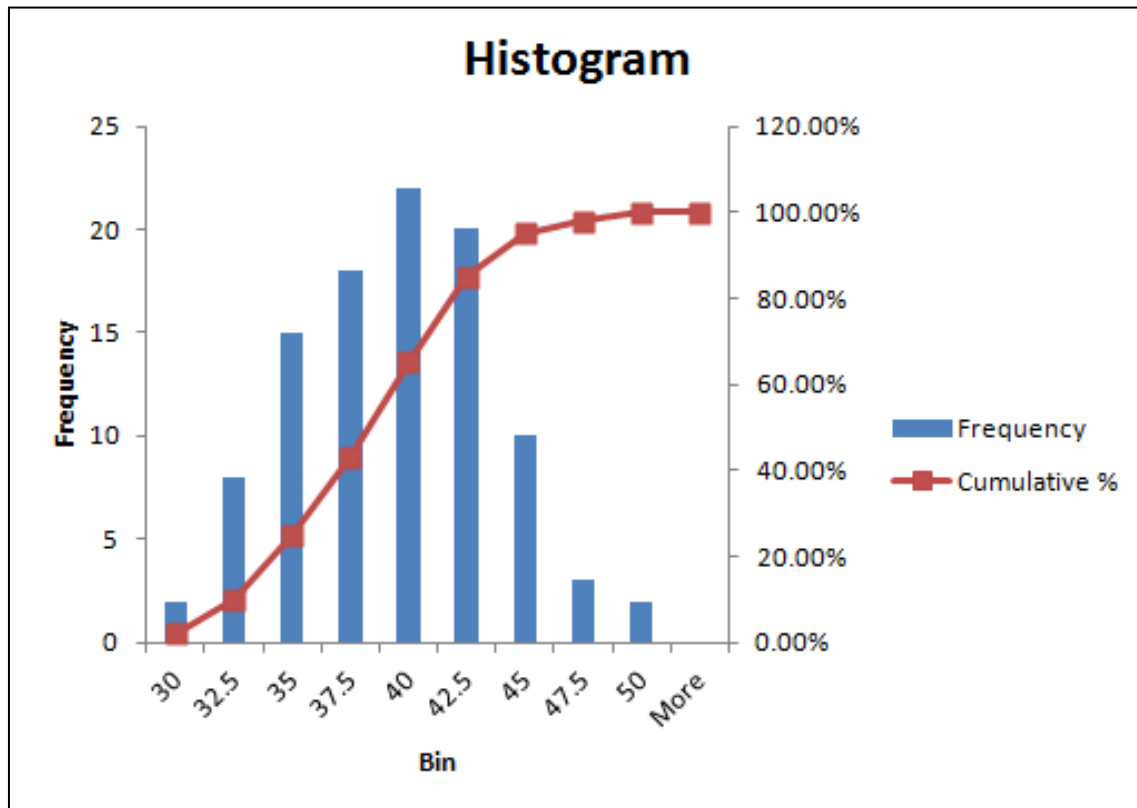

Figure 20: Estimated HE-RPA project duration in weeks

According to the results of the Monte Carlo Simulation shown in Figure 20, the HE-RPA project could have been accomplished in 42 weeks with an 80% confidence level. With a start date of January 27, 2011, a 42 week duration would have equated to a completion date of November 15, 2011. The 35 week duration that would have resulted

if each task took the average likely duration equates to a completion date of September 29, 2011 which matches the schedule shown in Figure 12. Based on the estimates provided by the HE-RPA development team members and the Monte Carlo Simulation there was only a 20% chance that the project would be completed by September 29, 2011. This estimation appears to have been overly optimistic. Although the schedule was optimistic, the critical path was identified and priority was given to tasks on the critical path. The team understood that the longer it took to accomplish tasks on the critical path, the higher the probability of unfavorable weather during taxi test and flight test.

3.9. System Integration

The planned integration efforts primarily focused on bringing all aspects of the hybrid-electric propulsion system, airframe, and ground control station together in a succinct manner to facilitate evaluation and testing. Integration efforts were split into two primary areas: incorporating the autopilot hardware and flight control modeling outputs into the baseline aircraft, AFIT 1, and combining the autopilot hardware, hybrid-electric propulsion system and motor controller into the HE-RPA, the “as-built” configuration, also called AFIT 2.

3.10. Evaluation

In order to satisfy the research objectives and to evaluate the HE-RPA concept as a viable option meeting the capability requirements set forth in the CONOPS, an orderly progression of testing was conducted. Governed by the TEMP, shown in Appendix K, testing efforts were allocated into three primary avenues as detailed in the test and

evaluation hierarchy, Figure 21. Planned concurrently, development and evaluation of the hybrid-electric propulsion system and airframes was completed prior to integration efforts and evaluation of a complete prototype HE-RPA system. A specific test methodology and test strategy for evaluation of the hybrid-electric propulsion system, airframe, and integrated HE-RPA was created and documented herein.

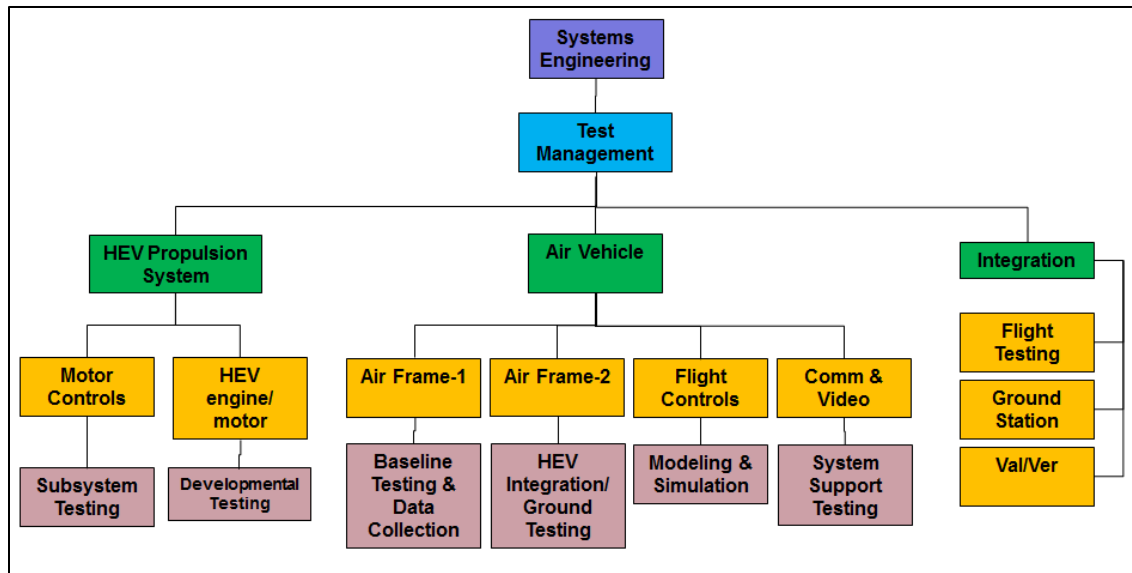

Figure 21: Test and Evaluation Hierarchy

3.11. T&E Strategy

A test and evaluation strategy was established in order to facilitate a logical and succinct progression of activities and is a component of the tailored SE process utilized in this effort. The primary purpose of testing this system was to collect information needed to generate a concept evaluation for a RPA powered by an HEPS. However, the cooperative aspect of this effort also necessitated minor additions and deviations to test events in order to satisfy the research objectives levied by Ausserer and Giacomo. These additions and deviations were primarily related to validation of the RPA flight simulation

model and integration and validation of the HEPS. Specific test events and the corresponding rationale are presented in Ausserer [12], Giacomo [13], and the bench, ground, and flight test cards in 0.

Testing followed a planned progression in order to maximize component availability and to minimize the impact of unanticipated results or findings. It also facilitated a piecemeal evaluation of component technologies including the standalone HEPS, the RPA platform, the autopilot and ground control station, and the motor controller logic/strategies. A detailed description of the planned test events is captured in the TEMP, Appendix K. The T&E strategy focused on event driven, incremental, evaluations in accordance with the T&E hierarchy. System testing was segmented into the three following areas:

- *Component/Hardware-in-the-Loop Bench Testing;*
- *Developmental Ground Test;*
- *Developmental Flight Test.*

3.12. Bench/Ground/Flight Testing

Coinciding with the tailored SE approach, evaluation and testing followed an event driven approach for both AFIT 1 and AFIT 2. Test events were in concordance with system maturity and risk mitigation measures. Initial bench testing was conducted to verify functionality of individual components of the system and integrated system functionality. Ground testing of the RPAs commenced after successful execution of the bench test cards. The test sequences and high level test objectives are detailed below.

3.12.1. Bench Testing (Component/hardware-in-the-loop)

Bench testing for this system consisted of evaluations of individual hardware components and subsystems for both the HEPS and the RPA airframes, as well as partially and fully integrated hardware and software components. Testing was conducted with prototype or representative items in order to simulate operational conditions and employment scenarios. The primary purpose of the component/hardware-in-the-loop testing was to observe system functionality and to collect and verify system data outputs. The objectives and sub-objectives shown in Table 6 were incorporated into the test and evaluation strategy and deemed necessary to develop the HE-RPA system and provide an objective concept evaluation. A synopsis of the results is presented in Chapter IV and detailed results were documented by Giacomo [13] and Ausserer [12].

Table 6: Planned Component/Hardware In-the-Loop Testing

Component/Hardware-in the-Loop Testing	
Basic Components	Integrated Components
Electric Motor Basic Function	Dual Mode Testing
ICE Engine Basic Function	HE Motor Only Acoustic Testing
Camera Component Testing	HE Motor and Propeller Acoustic Testing
Motor Controller	HE Motor Endurance Testing
	Engine Restart
	HE Mode Testing
	Software in-the-Loop-Testing

3.12.2. Developmental Ground Testing

The primary purpose of the developmental ground testing was to evaluate the performance of AFIT 1 (including baseline acoustic measurements) and the results of

integrating the HEPS into AFIT 2 along with the associated ground control station components and evaluation of the control strategies. Testing also focused on data collection only possible via a complete and functional system. Results of the testing determined the readiness of the system for flight testing. A breakdown of the test events is presented in Table 7.

Table 7: Planned Developmental Ground Testing

Developmental Ground Testing			
System Integration Test	Acoustic Testing - Airframe	Operator Familiarization and Training	Camera Testing
HE & ICE Control Surface Testing	Radius on Ground	Operational Checkouts	Range
HE Mode Control w/ all Electrical Systems Operating	Mounted on Stand	Operation	Camera switching
Software in-the-Loop Testing & Emergency Recovery		Emergency Procedures	
Ground Station Testing		System Recovery	

3.12.3. Developmental Flight Testing

The first flight tests were planned to be conducted with a prototype aircraft developed by CLMax. The purpose of the prototype flight test was to discern the initial airworthiness of the aircraft. Prototype testing was to be conducted solely at the discretion of the contractor with results being passed to AFIT.

Additional flight tests were to be performed on each of the two airframes developed, a basic ICE only configuration and HE configuration with the hybrid-electric propulsion system. One objective of the project was to show how the HE aircraft compared to a similar ICE aircraft in regards to quiet operation, long loiter time, and fuel efficiency. The purpose of the ICE airframe was to provide a control article for this comparison and provide spare parts as needed for the HE airframe.

The ICE airframe was to be delivered in a flight ready configuration and the HE aircraft would require HE motor integration prior to flight. The ICE aircraft would initially be flown with a weight and center of gravity (CG) configuration matching the HE aircraft. Flight test data would then be used in final integration of the HEPS into the HE aircraft. The HE aircraft and the ICE aircraft in an out-of-the-box configuration were to be flown under similar flight conditions for comparative purposes.

Finally, the HE aircraft was to undergo additional flight testing in order to evaluate the enhanced capabilities of the HEPS. Specific test events, along with the appropriate configuration, are presented in Table 8.

Table 8: Planned Flight Test Objectives

Flight Testing		
Both Aircraft Configurations	ICE Aircraft Configured with HE Weight and CG	HE Aircraft
Ground Takeoff	Maximum Takeoff Weight Determination	Fly with Different Numbers of Batteries
Catapult Takeoff (if required)	HE Mode Thrust Requirement Determination	Aerial Restart
Flight Mode Test (taxi, launch, climb, cruise, loiter, recharge, land)		Maximum Endurance
Proportional-Integral-Derivative (PID) loop shaping (longitudinal and lateral mode testing)		In-flight Mode Switching
Camera Tests		RemoteAuto Mode Switching
Endurance Testing		
Operator Familiarization and Training		
Software in-the-Loop		
Contingency Testing (ex. comm out)		
Acoustic Testing at Altitude		

3.13. Summary

This chapter mirrored a SEP and established the methodology for evaluating the proposed capability in the CONOPS using a tailored SE process with a concrete systems architecture, a qualitative and quantitative risk analysis, and an established TEMP. The next chapter outlines the results of the system integration and testing as well as the results of the tailored SE process.

IV. Results

4.1. Chapter Overview

With the development of the systems architecture, the SE approach, and airframe fabrication complete, the remaining effort shifted to system integration, testing and validation. The first section of the chapter focuses on evaluation of the baseline airframe configured with the ICE and Kestrel autopilot [38] (AFIT 1). The chapter continues with a discussion on the integration and modification efforts required in order to prepare AFIT 1 and progress to an evaluation of the HE-RPA (AFIT 2). The chapter then focuses on an evaluation of AFIT 2 and a discussion of the overarching research objectives and technology readiness level, including an evaluation of acoustic performance. Finally, a discussion on the ability of the HE-RPA to fulfill the capabilities specified in the CONOPS and the impact of using a tailored SE approach is presented.

The risk levels associated with progressive testing increased with the subsequent completion of test events. Initial testing was done at the modeling and simulation (M&S) level, followed by component/breadboard levels, then evolving into integrated system ground testing (hardware-in-the-loop testing), and finally culminating in flight testing, evaluating both AFIT 1 and AFIT 2.

Critical to overall system success, testing of the HEPS was conducted throughout all phases of assembly and integration. Flight testing efforts were divided between two vehicles; AFIT 1, the ICE only configuration and AFIT 2, the HE configuration. AFIT 1 was tested with a weight and balance configuration mirroring the weight and balance properties expected of AFIT 2. Lessons learned during the AFIT 1 flight test were

utilized in the final development and flight testing of AFIT 2. Tests that pose little or no threat to the HEPS and/or the airframes were conducted prior to test points deemed to pose a higher risk.

4.2. HE-RPA System Development and Integration

The baseline configuration, AFIT 1, was developed and flight tests yielded critical information about RPA performance and insight into the development of AFIT 2. Additionally, the HEPS was successfully integrated into AFIT 2. The original design of AFIT 1, AFIT 2, and the HEPS were altered throughout the development and fabrication process as more insight into the systems was acquired.

4.2.1. Baseline RPA – AFIT 1

As the HEPS is currently a one-of-a-kind prototype system, the baseline RPA, AFIT 1, was used to validate the airworthiness of the airframe before integrating and risking the hybrid-electric propulsion system. The airframe design was previously optimized by Harmon and Hiserote [20, 39]. The baseline airframe consisted of a foam and fiberglass fuselage and foam and fiberglass 12-ft wing set with aluminum spars. The wing set also included a set of two 18-inch wingtip extensions, allowing for a 15-ft wingspan if desired. A Honda GX35 (35cc) 4-stroke gasoline engine was also included with the baseline airframe. The GX35 provides approximately the thrust anticipated from the HEPS [25].

As the baseline airframe was delivered in a bare state with a standard elevator, rudder, aileron, and throttle configuration, modifications were needed in order to integrate the components required in order to add a Kestrel autopilot system and fly the

aircraft remotely or autonomously. More specifically, the Kestrel autopilot utilized static and dynamic pitot probes for airspeed determination, a GPS receiver for navigation, and a modem for communicating with the ground control station. The static and dynamic pitot probes were added to the center wing section, connecting to the autopilot through internally routed pitot tubing. Additionally, a u-Blox GPS [38] module/receiver was added to the top of the fuselage. A Microhard 900MHz digital modem and antenna [38] were installed into the fuselage in order to communicate with the Procerus Commbox v1.1 [38] and laptop component of the GCS. These components were easily integrated into the airframe as there was ample room and they are commercial parts recommended by Procerus, manufacturer of the Kestrel autopilot. Figure 22 provides a general view of the integrated components (outer wing panels not shown).

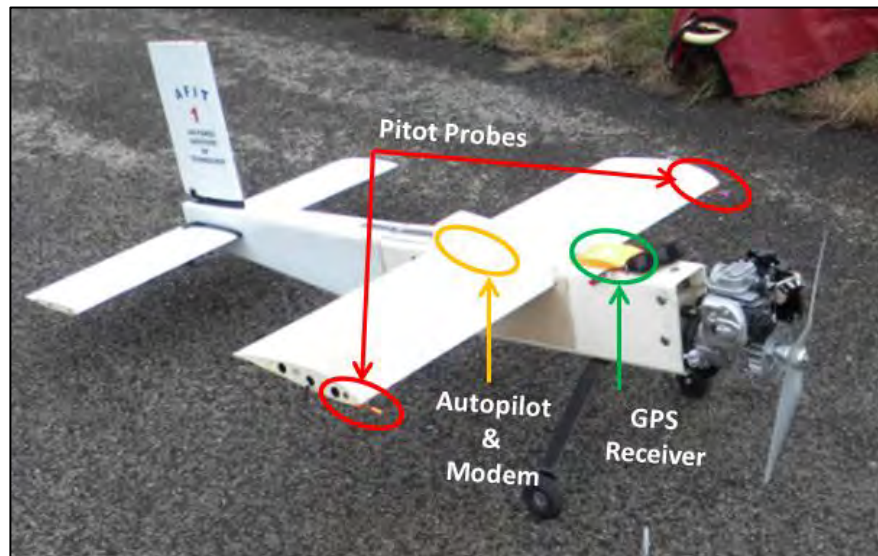

Figure 22: Integrated Components

As delivered, the baseline airframe was configured with fall-away landing gear in order to minimize in-flight drag. However, this necessitated a belly landing for recovery. For this effort, the impact of the added drag from the landing gear was deemed negligible

for the intended research objectives and a trade-off for the reduced landing risk was made by fixing the landing gear to the bottom of the fuselage. Additionally, a mishap on the first flight attempt and a subsequent taxiing off of the runway identified an inherent structural weakness at the wing attachment points. This finding lead to the incorporation of 1/8 inch thick plywood plates to the sides and underside of the fuselage for needed structural strength.

Since the airframe is a unique configuration and the stability and control and handling qualities were unknown. Therefore, an aircraft model created by Giacomo [13] was used to predict aircraft behavior and the identification of the required PID feedback loops required by the autopilot. The gains associated with the PID loops were loaded and integrated onto the autopilot via Procerus's Virtual Cockpit GCS software.

Although envisioned as a much smaller operational footprint, the GCS utilized for this development effort consists of a contractor provided trailer housing the laptop with the Procerus Virtual Cockpit software and Commbbox, antennas, video receiver, video monitors, and power sources. The integration of these components was straightforward as they used standard power, USB, coaxial, and RCA connections. The Virtual Cockpit GCS software is a companion product to the Kestrel autopilot enhancing the interoperability of system components. Figure 23 showing an overview of the integrated GCS is shown below.



Figure 23: Integrated GCS Components

An engine-kill mechanism, an independent method for aircraft position identification, and engine pull-start were integrated into AFIT 1 for safety reasons. Without a verified set of PID values, the first flight would be inherently risky. Therefore, a hobbyist 2.4GHz receiver and transmitter were used to activate a pico switch relay. The switch was tied to the engine magneto line, thereby providing an independent engine kill mechanism should the aircraft become uncontrollable or lose communication with the GCS and require that immediate safety measures be taken. Without the verified PID values, the integrated failsafe measures of the autopilot in the event of a loss of communication scenario could not be relied upon. In order to mitigate this risk, a camera pod transmitting to the ground station at 5.8GHz was constructed and integrated into the RPA. The camera pod provided an independent, self-reliant, visual reference to the operator. If the RPA were to lose communication with the GCS and fly out of visual

range of the operator, the video image would have provided an added opportunity to locate and recover the RPA.

To further improve safety, an engine pull-start was added to the back of the Honda GX35. The pull-start was easily integrated, as is a standard option for the Honda GX35. The addition eliminated the potential hazard associated with starting the engine from a position in front of the aircraft and the tripping hazard from the required battery and starter.

4.2.2. Hybrid-Electric RPA – AFIT 2

Coinciding with the previously generated “as-built” configuration presented in the architecture, the hybrid-electric RPA required significant integration effort to develop a functional system. Primarily, the HEPS, motor controller, and motor control software constituted the bulk of integration tasks. Additionally, modifications resulting from the evaluation of AFIT 1 were integrated into AFIT 2.

As previously discussed, the fabrication and integration of the HEPS was on the critical path and constituted schedule risk. Therefore, monitoring of the integration efforts was conducted on a weekly, even daily basis. Coordination of team member efforts was a critical aspect of the integration of the HEPS into AFIT 2. Although central to this effort, the integration of the HEPS is only briefly discussed here; detailed information on the HE integration effort is covered by Ausserer [12].

The HEPS consists of the Honda GX35 engine mounted in parallel with the AXI electric motor and linked via a belt drive. Intern team members associated with the HE system designed and fabricated the brackets, pulleys, and adaptors necessary to assemble

and mount the system into the HE-RPA [12]. Additionally, avionics mounting trays and restraints were fabricated in order to integrate and mount the Kestrel autopilot, avionics (motor controller, telemetry unit, and modem), fuel tank, and batteries into the fuselage. The associated wiring was also strategically placed to reduce electromagnetic interference (EMI) between power, signal, and transmission lines. An illustration of the HE-RPA layout is shown below in Figure 24.

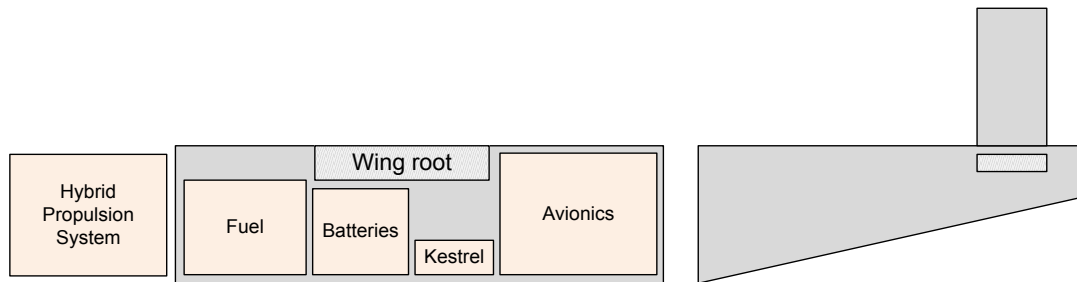

Figure 24: RPA Layout

As discussed in Chapter III Section 3.7, the original design of the HEPS was to include a microcontroller capable of self-selecting the optimal flight mode. Ideally, a fully operational HE-RPA would implement control in this manner. A PIC32MX795F microcontroller was selected as the hybrid controller. A full discussion of the microcontroller implementation is presented by Ausserer [12]. To reduce complexity and risk, in-line with the tailored SE approach, the scope of the microcontroller capabilities was scaled down. The resultant design was to implement a state machine on the PIC32 where the user, through some form of input, sets the flight mode via the Kestrel autopilot. However, through the course of the HEPS bench testing, an unanticipated electromagnetic incompatibility was discovered between the PIC32 and the Kestrel autopilot. Although implementing the mode control via the PIC32 was the preferred

alternative, it was determined that an even more simplified control strategy could be implemented and HE control could be ported over to the Kestrel.

The authors, along with Ausserer [12], decided to utilize an unused gimbal camera capability on the Kestrel. Originally intended to control two pulse width modulation (PWM) signals for two gimbal camera servo motors, the feature was instead used to control a PWM signal to the ICE throttle servo, with the second PWM signal converted to an analog signal for the electric motor control, via a PWM-to-analog conversion board provided by Blue Point Engineering. The board is pictured in Figure 25.



Figure 25: Servo to Analog Conversion Board by Blue Point Engineering

Operator control was implemented through a Graphical User Interface (GUI) developed by the authors, and linked to the Procerus Virtual Cockpit software. The GUI built upon an existing example interface provided by Procerus in their Developers Kit. An excerpt from the created C++ code is provided in 0. The GUI allows the operator to select a desired mode of HE operation, which is in-turn converted into two PWM signals whose values are a function of the instantaneous throttle signal provided by a manual operator or a direct autopilot command. A screenshot of the GUI is presented in Figure

26. This change in HE control is an additional deviation from the “as-intended” configuration to the “as-built” configuration.

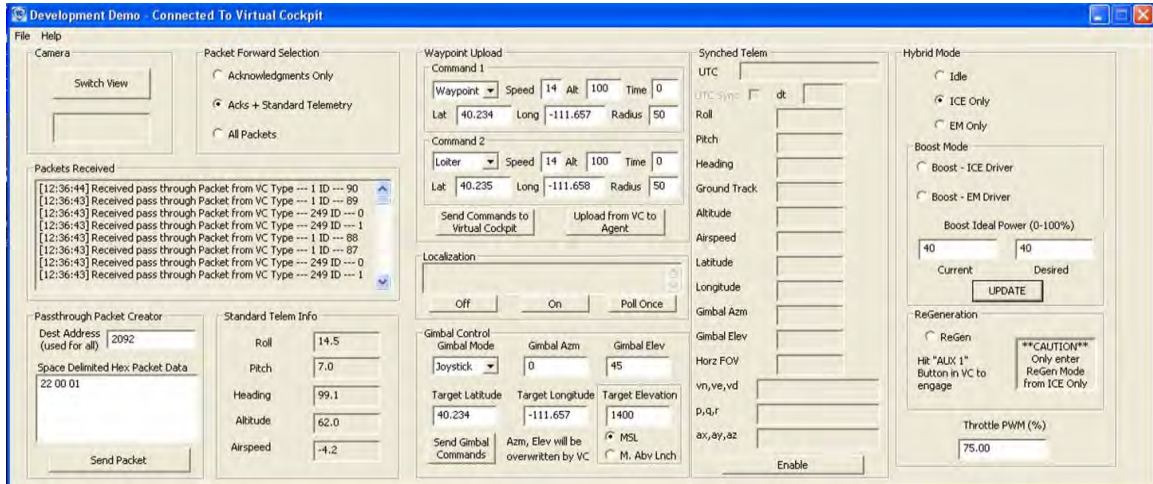

Figure 26: Virtual Cockpit user interface

4.3. AFIT 1 Taxi Testing

The taxi test of AFIT 1 was more eventful than anticipated. CLMax had been unable to get the Condor prototype airborne prior to delivery of the airframes. Some minor adjustments to the Condor airframe were made by CLMax based on lessons learned during attempts to fly the prototype. The primary change was the replacement of a tricycle landing gear configuration in favor of a tail-dragger configuration. The tail-dragger configuration increased wing incidence for greater lift and increase propeller-to-ground clearance. The tricycle gear configuration is depicted in Figure 27 and the tail-dragger configuration is depicted in Figure 28.



Figure 27: Tricycle Landing Gear Configuration



Figure 28: Tail-dragger Configuration

The Condor prototype failed to attain flight during preliminary testing by CLMax. An exact cause of this failure was not determined. In order to keep the development efforts moving forward, the development team decided to accept the associated risk and take delivery of the first airframe. Due to the previous difficulties with the Condor prototype, the HE-RPA development team did not expect AFIT 1 to produce any appreciable lift during the taxi test. Therefore, the wing sections were installed for the test along with a 2-bladed 18 x 12 APC propeller to evaluate the ground behavior of the fully configured RPA. For this test only, AFIT 1 was configured with only manual radio control components; integration of the autopilot was not necessary for this test. AFIT 1

taxied well during the taxi test and accomplished all required test objectives. During the initial portion of the taxi test, it was observed that AFIT 1 had more than adequate lift for flight by briefly leaving the ground. The HE-RPA development team was now much more confident in the ability for AFIT 1 to fly, due to the results of the taxi test.

4.4. Airworthiness of RPA Airframe

Due to a requirement for restricted airspace, flight tests were conducted at Hinsel Field located within Camp Atterbury Joint Maneuver Training Center, Indiana. In order to verify the airworthiness of AFIT 1, the baseline ICE powered airframe, a series of flight tests were conducted utilizing the build-up manner called out in the T&E strategy. Detailed flight test cards are presented in 0.

The initial flight of AFIT 1 resulted in an uncontrollable flight condition and a crash landing. It was determined that a miscommunication between the test director and operator resulted in the Kestrel autopilot being configured with an overly aggressive and unanticipated set of initial PID gain values. There was no fault found with the airframe. The RPA was recovered and repaired. A new pre-flight briefing process between team members was implemented to ensure that all members were aware of the test objectives and desired RPA configuration, including autopilot parameters.

Subsequent flights were accomplished without incident according to the flight test cards and direction provided by Giacomo [13]. A detailed breakdown of specific flight test objectives and results is presented by Giacomo [13]. The RPA airframe proved to be exceptionally stable with very predictable behavior under manual control. Takeoff distances, cruise speed, and stall speed were representative of the values predicted by

Giacomo [13], Harmon et al [20, 11], and Hiserote et al [39, 20]. The RPA also demonstrated acceptable stability and handling qualities at a configuration weight and center of gravity, (CG) simulating the expected values of the HE, AFIT 2, configuration. Initial results were used to validate the aircraft model created by Giacomo. The Kestrel autopilot was configured and flown with the model predicted PID values. Performance with these PID values was improved and once again acceptable, validating Giacomo's aircraft model. The RPA airframe fabricated by CLMax was deemed airworthy and suitable for integration of the HEPS.

4.4.1. AFIT 1 Loiter Results

A specific objective of the first flight test focused on evaluating the loiter characteristics of the RPA. AFIT 1 demonstrated the ability to continually operate with an engine run time of 77 min 11 sec. The flight test included suboptimal maneuvers including turning and changing elevation. AFIT 1 took off with approximately 30 fluid ounces of fuel and 5 pounds of ballast, weighing 30lbs 11 oz. AFIT 1 used 21.5 fl oz of fuel on this flight. In a subsequent flight, AFIT 1 also demonstrated that it was capable of flying with a half tank of fuel and a 10 lb ballast totaling 35+ lbs, the anticipated weight of AFIT 2. A test examining the loiter performance with the optimized 15-ft wingspan was called off after an initial flight caused concern about the structural capacity of the 15-ft wing under gusty wind conditions. No further testing was conducted on the 15-ft configuration.

4.4.2. Projected AFIT 1 Loiter capability

The data from the AFIT 1 loiter tests can be extrapolated to project a total flight time capability. The 87 octane gasoline utilized for testing weighs 0.6133oz/fl oz. There is room in AFIT 1 to include a second 60 fl oz tank of fuel and additional avionics batteries to support a long duration flight. Assuming a gross maximum takeoff weight of 35 lbs, AFIT 1 can remove the 10 lbs of ballast and replace it with fuel and extra batteries. Ninety additional fl oz of fuel would weigh 3.5 lbs, leaving 6.5 lbs for batteries and other payload.

$$90 \text{ fl oz} \times 0.6133 \frac{\text{oz}}{\text{fl oz}} = 55.197 \text{ oz} = 3.5 \text{ lbs}$$

With 120 fl oz of fuel and a burn rate of 77 min 11 sec of flight per 21.5 fl oz of fuel, AFIT 1 could conservatively fly for 7 hrs 10 min. Testing was not conducted with a flight profile optimized for endurance. Rather, it included flight maneuvers that consisted of abrupt changes in airspeed, altitude, and heading and therefore, the estimation was considered conservative.

$$\frac{120 \text{ fl oz}}{21.5 \text{ fl oz}} \times 4631 \text{ sec} = 25847 \text{ sec} = 7 \text{ hrs } 10 \text{ min } 11 \text{ sec}$$

4.5. HE-RPA Performance

Central to satisfying the previously stated research objectives, verifying the functionality and performance of the HE-RPA was a key aspect of the SE approach early on in this effort. Utilizing the build-up approach specified in the T&E strategy, evaluations of the HE-RPA were planned in an event driven, incremental fashion prior to

initial integration of the HEPS into the RPA airframe. The build-up approach in the T&E strategy called for bench testing, followed by ground and then flight testing of the integrated HEPS after successful integration into the RPA airframe, AFIT 2 configuration. Test events are covered in detail by Ausserer [12]; therefore only brief summaries of the test events and their impact on satisfying the research objectives are presented here.

4.5.1. Bench Test

The primary objective of the bench test was to validate functionality of the HE system and the control and safety procedures intended for flight testing. A build-up approach for the testing was utilized and step-by-step procedures were captured and results documented in a set of test cards included as 0. Basic functionality of the HE-RPA was successfully demonstrated in all modes of operation to include: Idle, ICE only, EM only, both Dual (Boost) modes, and Regeneration. A summary of the results is presented below in Table 9.

Table 9: Hybrid system bench test objectives and results

Test #	Objective	Result
BT-01	Verify functionality of system in ICE only mode.	Successful
BT-02	Verify Functionality of system in EM only mode	Successful
BT-03	Verify mode transition from EM only to ICE only mode works.	Successful
BT-04	Verify mode transition from ICE only to EM only mode works	Successful
BT-05, BT-06	Verify both dual modes function. BT-05 verifies the ICE can operate at a constant set point while the EM throttle is varied. BT-06 verifies the EM can operate at a constant set point while the ICE throttle is varied. Both tests also check that the set point of the constant component may be changed.	Successful
BT-07	Verify the ICE kill switch functions and that the EM still operates after the ICE is	Successful

	killed.	
BT-08	Verify the EM kill switch functions and that the ICE still operates after the ICE is killed.	Successful
BT-09	Verify the ICE crossover switch to pass ICE control from the Gimbaled Camera line to the Kestrel throttle line during an emergency functions properly.	Successful
BT-10	Verify that Regen mode works properly.	Successful

Bench testing of the HE-RPA demonstrated the HE technology could be successfully implemented and integrated into an RPA and is a viable option for an RPA propulsion system. The bench testing also demonstrated that a control strategy for the HEPS could be implemented for an RPA. Although, the envisioned self-controlled capability via the PIC32 microcontroller was not achieved, implementation via the Kestrel autopilot and the Virtual Cockpit GUI demonstrated that the HE-RPA could be remotely controlled; albeit in limited fashion. The HE-RPA bench test setup is shown in Figure 29.

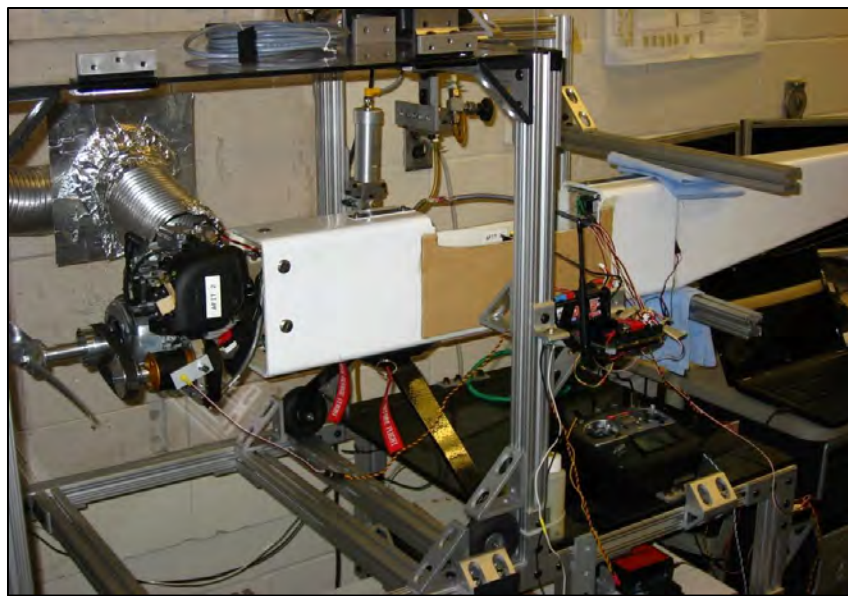

Figure 29: HE-RPA Bench Test Setup

4.5.2. Ground Test

The HE-RPA team ensured that the HE-RPA worked in all of the required modes on the bench prior to attempting the taxi test. In spite of the successful demonstration of all the operational modes of AFIT 2 on the bench, there were issues with some of the modes of operation during the first AFIT 2 ground test. On the flightline, there were several issues trying to get both the gas and electric modes to function properly before accomplishing the test objectives on the ground test cards detailed in 0. There was an issue with switching between modes and being able to get one mode or the other to work but not both. This was successfully tested on the bench just prior to the ground test.

AFIT 2 was returned to AFIT and the HE-RPA development team was unable to duplicate the issue in the lab so AFIT 2 was returned to the flightline for another taxi test. This time, the gas and electric modes worked, but the Seagull telemetry system was not transmitting the telemetry data to the ground control station. Some chatter in the servos, which appeared to get worse as time passed, was also observed. The team was unable to duplicate the erratic behavior in a lab environment, so it was concluded that the servo chatter may have been due to interference in the 900 MHZ range, the communication frequency of the autopilot to the GCS. The test location was also within range of numerous electromagnetic testing facilities located at Wright-Patterson Air Force Base. The servo chatter was making the rudder, ailerons, and even the ICE throttle position servos quickly move to a maximum position and then move back to the neutral position. Sporadically, several servos would move at once, and sometimes

just one servo would move. The servo chatter happened about once every 10-20 seconds, further indicating external EMI.

Although not all of the systems were working as intended, the HE-RPA development team decided to taxi the aircraft in the different modes and demonstrate the AFIT 2 capabilities, even though the telemetry data would not be transmitted or recorded according to the ground test cards. AFIT 2 successfully taxied under EM only power in the first and second HE taxi test events and taxied in both dual (boost) power modes and the ICE only mode during the second HE taxi test. Issues observed while taxiing AFIT 2 in ICE only mode were deemed insignificant because the chatter in the ICE throttle servo kept shutting off the ICE engine. AFIT 2 was taxied back to the staging area after the ICE engine was shut off using the EM power, showing the potential of redundant systems in the HE-RPA. Although the ground test was not entirely successful, the HE-RPA team concluded that AFIT 2 was ready to progress to flight test due to the demonstrated reliability of the system in the lab and confidence that the erratic behavior was due to EMI. The team also ensured that the issues observed during taxi test were verified on the flight line at Camp Atterbury prior to flight test.

4.5.3. AFIT 2 Flight Test

No successful flights were completed with AFIT 2 and no flight test data was gathered due to a mechanical failure in the landing gear, which resulted in an unexpected departure from the runway. The runway departure caused significant damage precluding continued testing. Ausserer suggested that AFIT 2 could fly a loiter profile for an hour and a half without going into regeneration mode to charge the batteries. It is difficult to

project a realistic loiter capability for AFIT 2 including segmented ISR via battery regeneration without supporting flight test data. Based on the fuel consumption data collected from AFIT 1, it is reasonable to assert that the HE-RPA concept has the potential to fly more than 4 hours and fulfill the capability gap identified in Chapter I; the capability gap between EM powered RPAs and ICE powered RPAs. Exactly how long the HE-RPA could fly including segmented ISR with battery regeneration has yet to be demonstrated.

4.6. Technology Readiness

Based on the results from bench, taxi, and flight test, the technology readiness level (TRL) of the HE-RPA is level 5. The HE-RPA capability has been demonstrated in the lab via bench testing as well as modeling and simulation but has not been demonstrated in a relevant environment. Even if the HE-RPA had flown during flight test, it would still require a flight test where a technician flew the RPA and not the engineer who designed it. Further human system integration efforts, upgraded HE targeting and control system, and flight test demonstrations are required prior to a solid TRL level 6 assessment.

4.7. Acoustics

A primary component of this effort was to determine if the addition of the HEPS results in a reduction in the acoustic signature of the RPA. The T&E strategy called for evaluations of both the ICE and HE configurations in order to make the comparison.

Although AFIT 2 was not flow successfully, baseline testing was conducted with AFIT 1

and qualitative evaluations of AFIT 2 were made based on findings with an EM and multiple propellers.

4.7.1. Measurements and Results

Acoustic measurements of AFIT 1 were collected at Camp Atturbury concurrently with flight test efforts. Initial measurements of AFIT 1 were taken on the ground in its tail-dragger configuration with a 40% throttle setting on the ICE using the Ivie IE-45 audio analysis system [40], also referred to as a sound pressure level meter. The A-weighted measurement scale was chosen to remain consistent with comparable efforts [41]. The 40% throttle setting corresponds to an observed cruise condition obtained via initial flight testing of AFIT 1, by Giacomo [13]. Measurements were recorded in units of dB(A); hereto referred to as simply dB (decibels). The objective of this first test was to evaluate different propeller combinations. Measurements were taken at a 50-ft radius with the orientation depicted in Figure 30. No measurements were taken at the 315° position (off the nose of the aircraft) due to significant disruptions caused by the location of the flight test trailer.

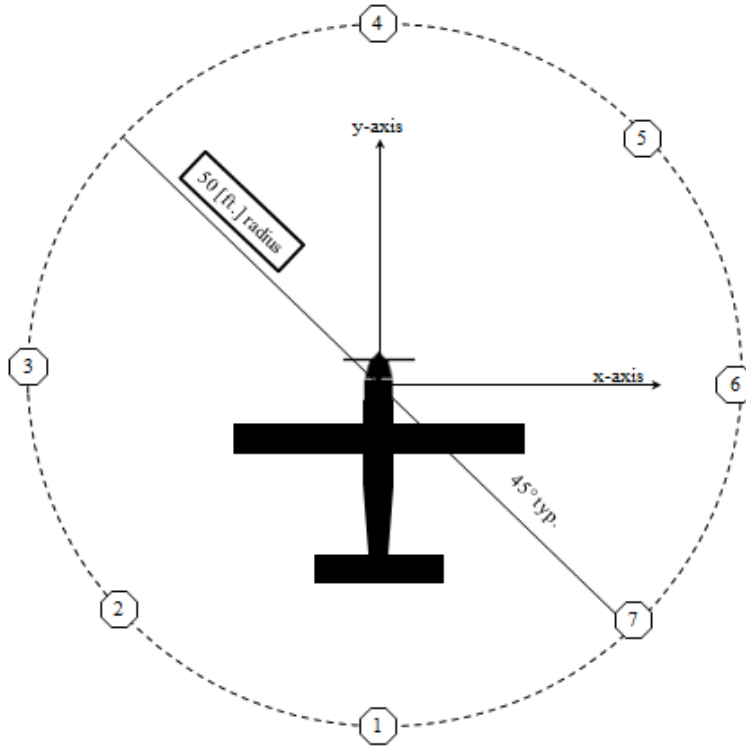

Figure 30: Acoustic Measurement Location

Measurements were taken on four different propellers: a 2-bladed 18 x 10 APC propeller, a 3-bladed 15.75 x 13 APC propeller, a 3-bladed 16 x 11 Carbon Fiber Mejzlik propeller, and a 4-bladed 15.5 x 10 APC propeller. Images of each propeller are shown in Figures 31-34.

Although these propellers do not provide equivalent performance (i.e. thrust) for the same rotational speed, they were deemed common and acceptable substitutes without resorting to custom designs. They were also chosen to facilitate the rapid prototype SE approach used throughout this effort.



Figure 31: 2-Blade 18" x 10 APC Propeller



Figure 33: 3-Blade Carbon Fiber Propeller



Figure 32: 3-Blade APC Propeller



Figure 34: 4-Blade APC Propeller

Recorded measurements for the 2-bladed 18 x 10 APC propeller are presented in Figure 35. The 2-bladed 18 x 10 APC propeller was selected based on previous findings by Rotramel [14] and serves as the baseline for comparison. Intuitively, the lowest dB values were obtained off of the nose of the RPA at position 4, while the highest values were obtained at position 5. Position 5 corresponds to the orientation of the exhaust port on the muffler.

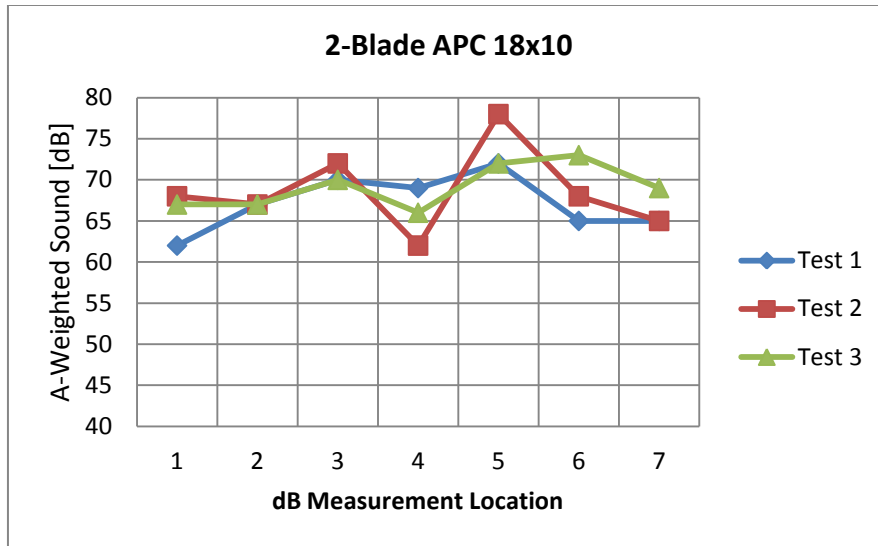

Figure 35: dB Measurements 2-Blade APC18 x 10 at 50-ft

Next, the 3-bladed 15.75 x 13 APC propeller was tested and results are presented in Figure 36. This blade exhibited similar behavior trends in regards to the minimum values obtained at position 4 and higher values obtained at position 5. The highest dB values were recorded at position 3. The average dB value was noticeably higher for this propeller than the 18 x 10 APC. Although not intended to be an investigation on detailed performance of propellers, it was surmised that higher values at position 3 result from an interaction between the clockwise propeller direction and an air compression effect with the ground. This is consistent with findings in [41].

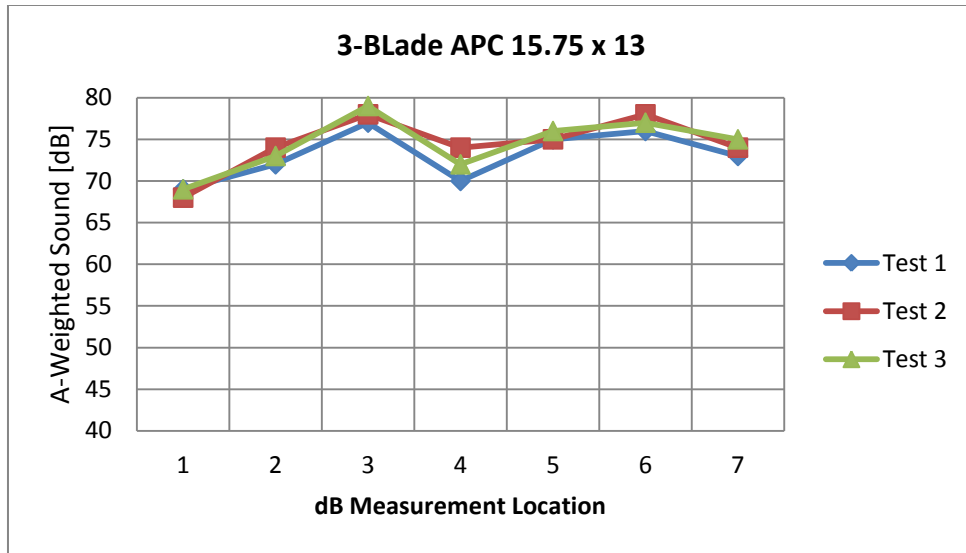

Figure 36: dB Measurements 3-Blade APC15.75 x 13 at 50-ft

Results for the Mejzlik 3-bladed 16 x 11 carbon fiber propeller are shown in Figure 37. This propeller had significantly lower dB values at every measuring location along with the expected increase near the muffler port. This propeller was significantly more rigid than the others with a smoother surface finish. No conclusions were made about the observed performance of this propeller.

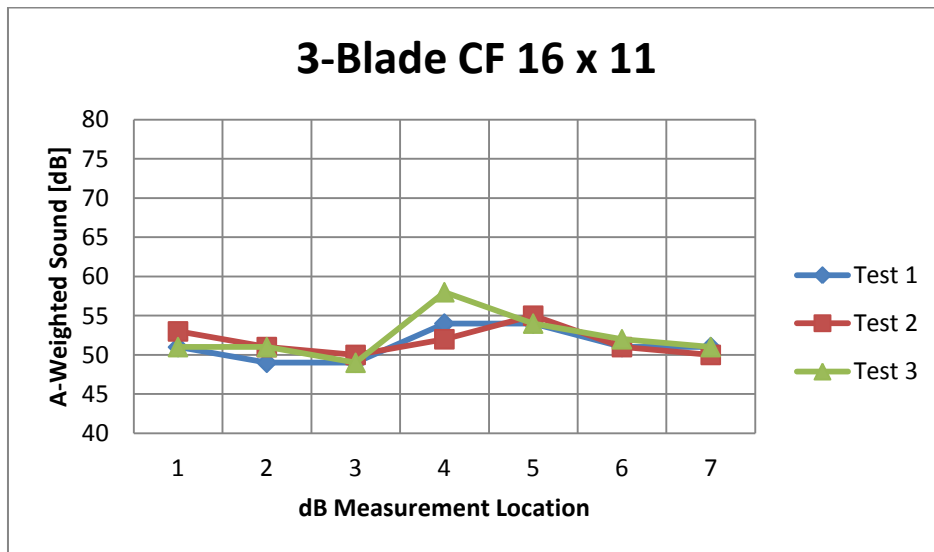

Figure 37: dB Measurements 3-Blade CF 16 x 11 at 50-ft

Results for the 4-bladed 15.5 x 12 APC propeller are shown in Figure 38. This propeller also had significantly lower dB values than the baseline at every measuring location without the expected increase near the muffler port. This propeller also had its highest dB values recorded in front of the aircraft. Although not captured quantitatively, the qualitative observation put this propeller in a different audible frequency range than the other three. This propeller was significantly more flexible and shorter than the others. A summary of the average dB measurements collected for each propeller is shown in Figure 39.

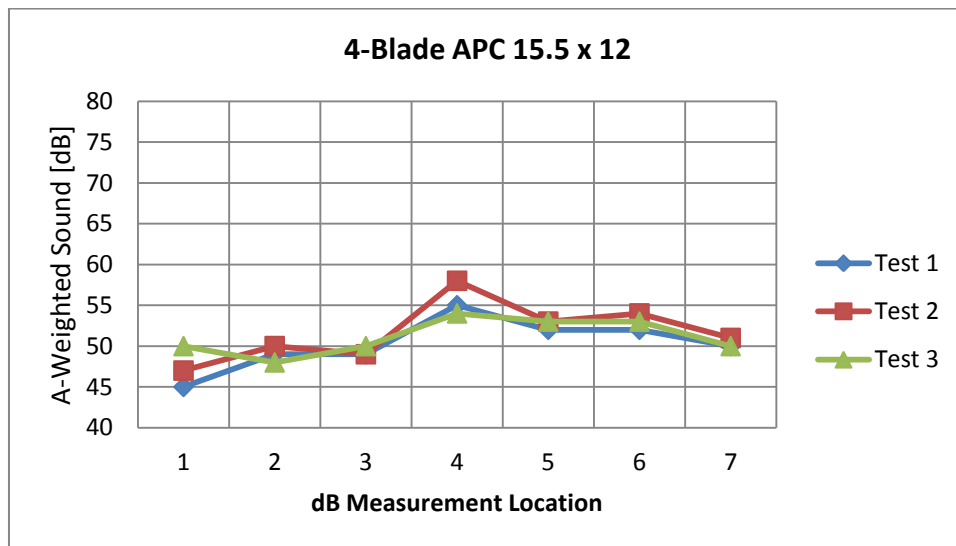

Figure 38: dB Measurements 4-Blade APC15.5 x 12 at 50-ft

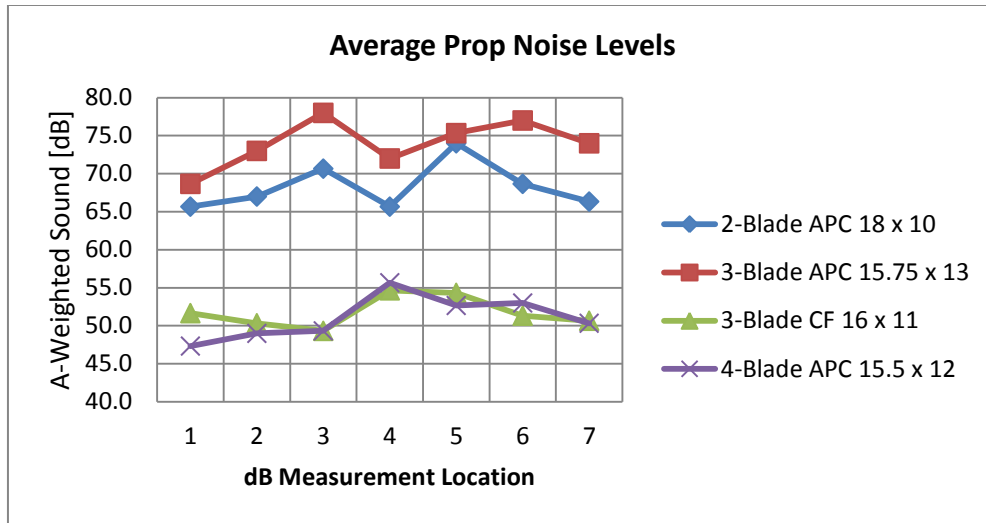

Figure 39: Average Propeller dB at 50-ft

After collecting acoustic measurements on the ground, AFIT 1 was flown at 40% throttle in an oval flight path at altitudes of 300-ft, 500-ft, 700-ft, and 900-ft. Although overhead data was collected, excessive ground level wind noise invalidated the results. Of note, team members concluded that at the 700-ft and 900-ft altitudes, AFIT 1 was barely discernible to the human ear given ground wind speeds of 3-7 mph for all propeller configurations. This finding is similar to one made during testing of the Silver Fox [30]. Z

Although the in-flight acoustic measurements were invalidated by the wind, the manual pilot of AFIT 1 rank ordered the props on responsiveness to throttle command (Table 10). The 2-bladed 18 x 10 propeller provided the best performance, followed by the Mejzlik 3-bladed 16 x 11 carbon fiber propeller. The 3-bladed 15.75 x 13 APC propeller was third and the 4-bladed 15.5 x 12 APC propeller performed the worst.

Table 10: Responsiveness Performance

Responsiveness Performance	
Rank	Type
1	2-Blade 18 x 10 APC
2	3-Blade 16 x 11 Mejluk CF
3	3-Blade 15.75 x 13 APC
4	4-Blade 15.5 x 12 APC

Electric motor only measurements were collected on a test stand at AFIT. Testing was limited to a head-on position (position 4) and limited to only the 3-bladed 15.75 x 13 APC propeller, a 3-bladed 16 x 11 Carbon Fiber Mejluk propeller, and a 4-bladed 15.5 x 12 APC propeller. Testing was not conducted on the 2-bladed 18 x 10 propeller due to unavailability at the time of the test. Both noise (dB level) and frequency response (Hz) findings are presented in Table 11 and Table 12.

Table 11: Electric Motor Acoustic Noise Testing Results

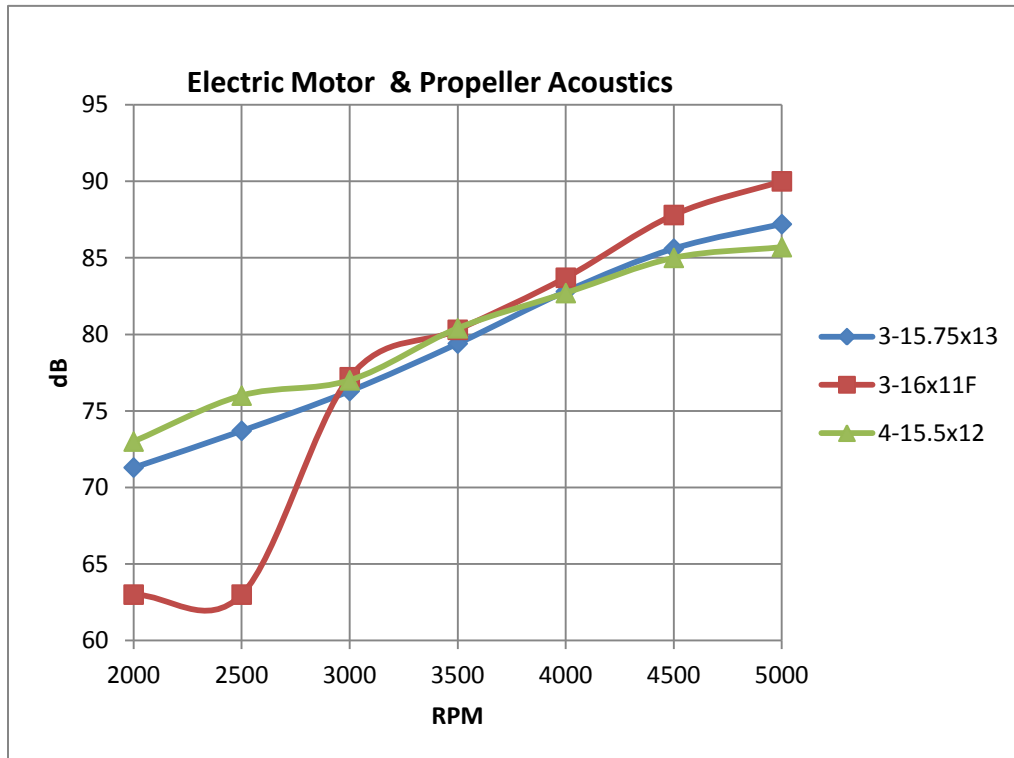
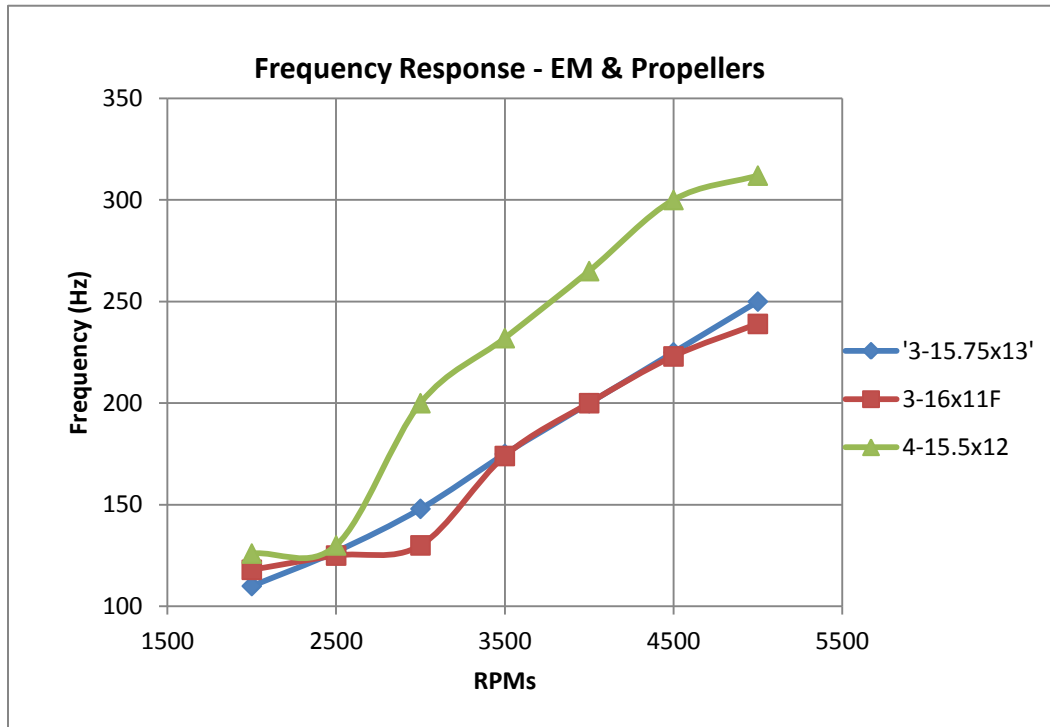

Table 12: Electric Motor Acoustic Frequency Testing Results



4.8. Evaluation of Tailored Systems Engineering Process

The event driven schedule with meaningful systems engineering related artifacts assisted in focusing the rapid development of the HE-RPA. Particular attention was paid to accomplishing tasks on the critical path as expeditiously as possible. Tasks that were not on the critical path were monitored to assure that they did not become a part of the critical path.

4.8.1. Schedule

Although the Monte Carlo simulation predicted that the project would take about 42 weeks to accomplish with an 80% confidence level, it actually took 56.6 weeks to develop the HE-RPA. Figure 40 shows the planned development schedule and is repeated from Chapter III, shown again for ease of reference. Figure 41 shows the actual

development schedule. By comparing both versions of the schedule, the reader can compare the planned versus actual completion time for each scheduled task.

The development of airframe I and airframe II was done in parallel since the two base airframes were very similar; airframe II did not include a propulsion system since the propulsion system was to be developed by the HE-RPA team. The development of the airframes was not on the critical path, so even though delivery was delayed by 5 months it did not delay the project as a whole.

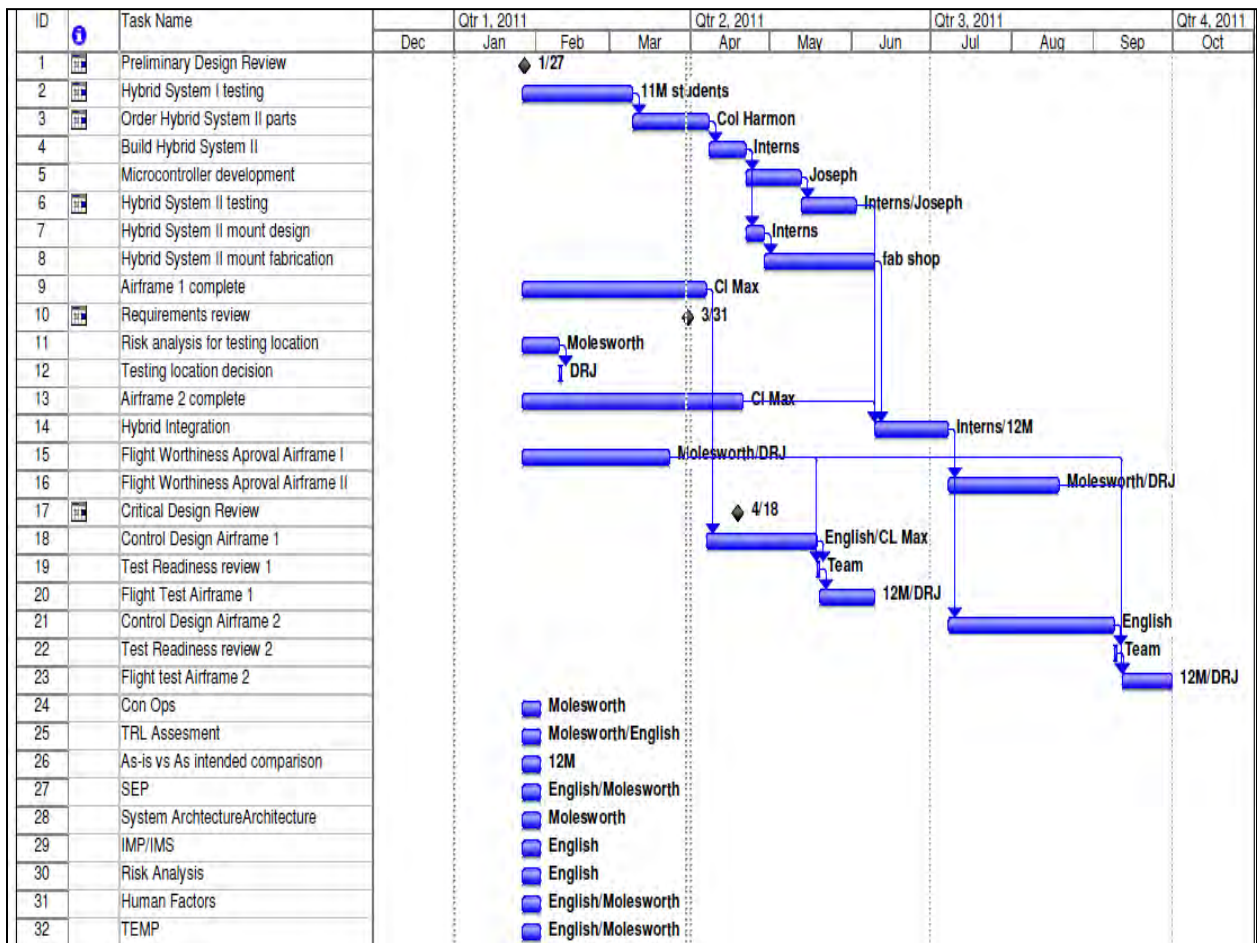

Figure 40: Planned HE-RPA Development Schedule

Although the longest task delay in the project was the airframe development, the HEPS development in aggregate constituted a much longer delay. It took much longer to build and test the HEPS than anticipated. There were also significant delays regarding the microcontroller development. Three different microcontrollers were used during the development of the system. In the end, a function built into the Kestrel Autopilot that was not being utilized was modified to serve as the microcontroller for the system. The HEPS development, including its many setbacks, is discussed at length by Ausserer [12]. The result of the setbacks was that much was learned about how not to build an HEPS, and much was learned about how to build a simpler, more robust HEPS than originally envisioned.

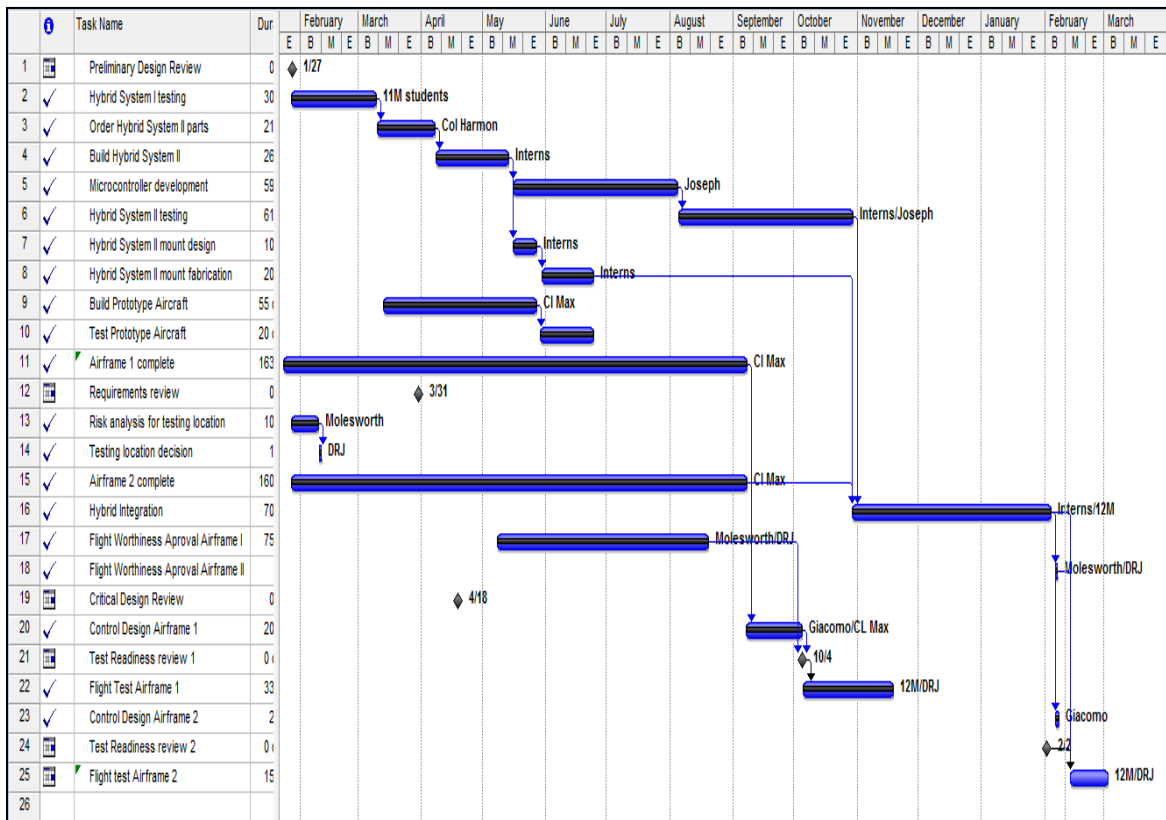

Figure 41: Actual HE PRA Development Schedule

Another task with a significant delay was the integration of the HEPS into airframe II to form AFIT 2. Part of this delay happened because the available space for avionics in the avionics bay changed several times. Ausserer [12] provided the required dimensions of the avionics bay to CLMax but did not know that CLMax would put a hinge and other hardware in the avionics bay. This resulted in a redesign of the avionics mounting surfaces. Later, while placing the components in the avionics bay, Ausserer [12] found that other hardware was also added to the avionics bay resulting in yet another design of the avionics mounting surfaces. The team also decided to add two bench tests and a taxi test to the integration portion of the schedule. The first bench test included the HEPS and the avionics as well as the propeller. The second bench test of the integrated system included the antennas and all other components required for flight test besides wings. The additional testing took more time than initially planned, but identified unanticipated deficiencies in the “as-built” system configuration that had to be corrected before flight test, such as a bolt that needed to be reverse threaded to prevent the propeller from flying off the aircraft during operation. There was no time planned or allocated for troubleshooting EMI issues even though it became a major source of delay late in the effort.

Although the project was designed to be event driven, the end of the project coincided with the graduation date of March 22, 2012. The HE-RPA development team knew that the project was aggressive for the given schedule and agreed that the team would take the project as far as possible in the time given. The fixed graduation date assisted in scoping the concept during development to increase the probability of

accomplishing the majority of the objectives, outlined in the CONOPS, at project completion.

4.9. Qualitative Risk Analysis Highlights

A lesson learned from the results of the qualitative risk analysis was that efforts taken to mitigate one risk may also assist in mitigating another risk. The team requested that the fuselage of the HE-RPA be sent earlier in order to expedite the integration of the HE system in the fuselage. The fuselage that was shipped ended up being a spare fuselage that was used to repair the aircraft after several rough landings. Although the spare fuselage was ordered to mitigate the integration risk, it actually mitigated the risk of rough landings and did not result in a mitigation of the integration schedule risk.

When discussing the progress of airframe fabrication with CMax, CLMax explained that after several flight test attempts, the fabrication prototype aircraft did not fly. CLMax requested more time to develop the airframe so that a two cycle engine could be ordered and replaced in the prototype airframe for further flight test events. The HE-RPA development team determined that the proposed schedule delay resulting from an integration of a two cycle engine was not worth the potential to gather more information about the prototype airframe.

The development team knew that the airfoil being used was a proven airfoil and was stumped as to why the prototype airframe did not fly. The team requested that CLMax deliver the airframes as planned even though the flight potential was unproven. The team decided to accept the technical risk of having an unproven airframe in exchange for the shorter delivery schedule. The team felt that the group of aeronautical engineers

involved in the project with the assistance of aeronautical engineering professors and CESI support contractors would be able to get the airframe to fly. The team knowingly agreed to pay CLMax for two airframes that may never fly and understood that the majority of test objectives would not be accomplished if the airframes were not capable of flying. A more thorough discussion of the qualitative risk analysis results is included in 0.

4.10. Quantitative Risk Analysis Results

As discussed before, the primary risk to the project was schedule risk. Due to the generous funding from the project sponsors, the HE-RPA development team was able to acquire parts and labor required for development in order to reduce the total potential development time of the system. Further, spare parts were ordered where appropriate to avoid further delays should they become necessary.

As discussed in Chapter III, a survey of the HE-RPA development team members was taken to determine the expected duration of each task in the network diagram. The average of the responses for minimum, likely, and maximum duration in weeks are repeated below in Table 13 with the actual task completion time included as well.

Table 13: Network Diagram Activities with Results

Activity	Description	Duration			
		min	likely	max	actual
A	Build EM system	2.25	4	6	21.7
B	Build ICE system	2.75	4.125	7	21.7
C	Build Airframes	17	23.5	36.5	28.55
D	Bench test EM system	1.5	2.5	4	4.15
E	Bench test ICE system	1.5	3.25	8	4.15
F	Build HE system	4.75	7.25	14	1.3
G	Integrate AFIT 1	1.5	3	5	1.3
H	Bench test HE system	2.5	3.5	5.75	12.15
I	Taxi test AFIT 1	0.875	1.25	2.25	0.15
J	Integrate AFIT 2	1.5	3	5	13.3
K	Flight test AFIT 1	2.25	3.5	6.5	12.15
L	AFRL flight test approval	2	4.25	7	0.15
M	Bench test AFIT 2	1.25	2.75	4.25	2.15
N	Taxi test AFIT 2	0.875	1.5	2.75	1
O	Flight Test AFIT 2	1.75	3.5	6.75	0.85

Many of the tasks took a lot longer to complete than expected, showing that the HE-RPA development team was either incredible unlucky or did not adequately appreciate the level of schedule risk in the project.

Tasks F, G, I, and L took less time than the minimum expected amount of time to complete. Task F, *build HE system*, took less time according to the network diagram because it was being designed as the EM and ICE systems were being designed. This is more of an artifact of the network diagram and the definition of dependent and parallel tasks. The HE system could not be built without the ICE or EM system and many issues found while building the HE system would cause redesigns of the EM, ICE or both systems. The duration of task G, *integrate AFIT 1*, was just below the lower end of the projected duration. Once the airframes were delivered, Co-Operative Engineering Services Inc. (CESI) was able to get the system ready for taxi test as planned. The

extensive experience of CESI in flying hobby aircraft assisted in keeping this task under schedule. Task I, *taxi test AFIT 1*, took a minimum amount of time because integration of AFIT 2 was being completed the morning of the taxi test, and the taxi test was accomplished in one day. Task L, *AFRL flight test approval*, took a minimum amount of time; AFRL decided that AFRL flight test approval was not required since AFRL was not directly funding the flight test. The fact that this task could be accomplished in parallel with another task also assisted in keeping it off the critical path.

The duration of tasks C, E, M, N, and O fell within projected timeframe. The HE-RPA development team correctly predicted that task C, *build airframes*, would take longer than expected. Fortunately, the airframe that was delivered worked and was able to support the required test objectives. Task E, *bench test ICE system*, stayed within the expected range. Again, this is more of an artifact of the network diagram. Two ICE engines were damaged, one permanently, during bench testing resulting in a redesign of the ICE system. The redesign is captured in the ICE system build time and not in the ICE test time. Many hours were spent in the lab testing different configurations of the HE system with the ICE running to see if the ICE system would work while integrated as a part of the HE system as a whole.

Task M, *bench test AFIT 2*, did not take a long time. This was likely due in part to the learning curve. The bench testing of the integrated system was similar to the bench test of the HE system but it included the airframe and the propeller. Task N, *taxi test AFIT 2*, also stayed within schedule. Having the prior experience of taxi testing AFIT 1 and extensive bench tests of AFIT 2 assisted in clarifying and accomplishing the taxi test

objectives that were accomplished. Task O, *flight test AFIT 2*, also took as much time as expected. The motivation to complete the flight test prior to graduation assisted in making sure everything was ready to go for flight test pending acceptable flight weather. Task O remains partially completed since AFIT 2 crashed in flight test and never flew. It still remains to be seen if the HEPS can provide enough thrust to get AIFT 2 airborne. All HEPSs were functioning properly when the landing gear assembly broke and a wheel came off during takeoff.

Tasks A, B, D, H, J, and K took longer than the maximum expected amount of time to complete. Task A, *build EM system* and task B, *build the ICE system* were accomplished in parallel. Some delays that could be attributed to other tasks were included in the delay for tasks A and B since the network diagram is not set up iteratively. Issues in later tasks that resulted in rework of earlier tasks are charged to the earlier task. It could be argued that some of the delays in tasks A and B are due to the heavier class schedule during this period but a lighter class schedule would not have shortened the fabrication time of many of the parts built during tasks A and B. In spite of a heavy class schedule, Ausserer [12] directed the interns in development of HE system components.

Task D, *bench test EM system* took one day longer to complete than the upper bound of the projected duration. This timeframe does not include much of the rework that was done during the EM system development. Task H, *bench test HE system*, was delayed and some of the delay could be attributed to the iterative behavior of testing, which is not captured by the diagram. Including the iterative nature of the project with the

network diagram would not have sped up the project completion and would not have changed what appears on the critical path, it would have only changed the accounting of when tasks were completed.

Task J, *integrate AFIT 2*, took longer than expected due to the lack of communication between team members and CLMax. Integration efforts were addressed at the onset of the project and an extra fuselage was shipped to ensure that the avionics would fit. The fuselage did not include the hinges or the other hardware required for integration, so the risk mitigation efforts were ineffective in reducing the amount of time required for system integration.

Task K, *flight test AFIT 1*, was also delayed. Flight test delays were anticipated due to the high level of coordination required between CESI support contractors, HE-RPA team members, Camp Atterbury scheduling, advisors, and weather. There was a delay in coordinating an acceptable flight test date for AFIT 1. Since AFIT 1 was not on the critical path, it did not delay the project. Ausserer, who was primarily working on the HEPS development, did not attend the AFIT 1 flight test and continued working on the HEPS development.

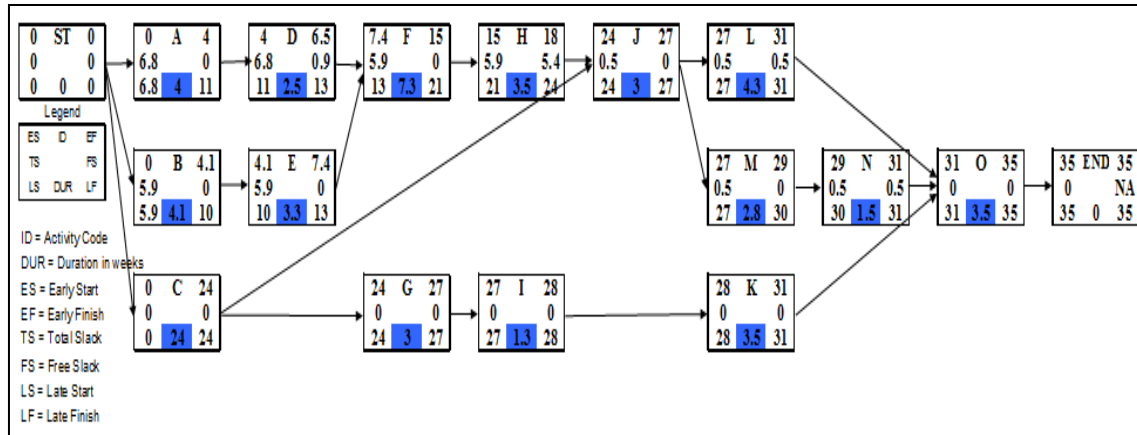

Figure 42: HE-RPA network calculations

Figure 42 shows how long the project would take if the durations from the likely column in Table 13 were used, and is repeated from Chapter III for ease of reference. Figure 43 shows how long the project actually took by using the durations in the actual column from Table 13 to calculate the network duration as well as the start, finish, and slack times. The project lasted 56.6 weeks. Not one of the 100 trials in the Monte Carlo simulation took 56.6 weeks. The average pass through the Monte Carlo simulation took 38.2 weeks to accomplish with a standard deviation of 4.3 weeks. The actual project duration of 56.6 weeks is 4.3 standard deviations above the average.

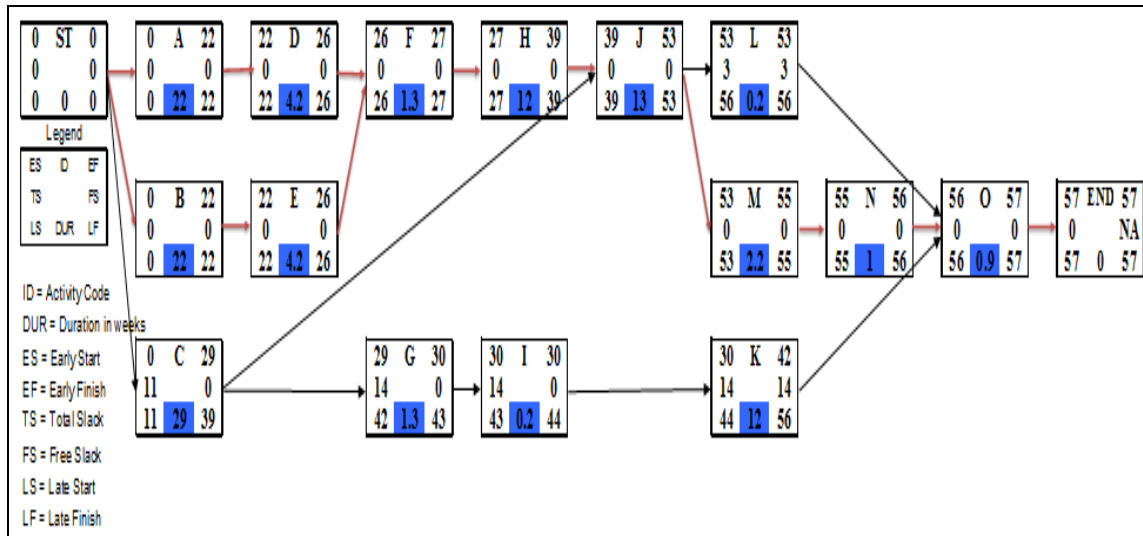

Figure 43: Actual Network Diagram

The average of the team members' approximate minimum, likely, and maximum task durations were used to generate triangle distributions for each task in the network diagram. The triangle distribution was selected because it can compensate for a high level of uncertainty. If the team member minimum, likely, and maximum duration approximations were accurate, then it would be almost impossible for the project to take 56.6 weeks to accomplish. It is almost certain that the projections were not accurate and that the long schedule duration is due more to the team not understanding the entire schedule risk of each task. Prior experience levels of the team members could have been used to make adjustments to the task estimations. Additionally, it would not be accurate to say that the team was delayed due to bad weather on account of the unseasonably warm weather experienced over the fall and winter of 2011-2012. Given the lack of experience of the team on similar projects, the inaccuracies of the schedule predictions are less surprising.

4.11. Results Summary

By using a tailored SE approach, the HE development team was able to develop and test two comparable airframes. The development of AFIT 1 assisted in the development of AFIT 2 and served as a baseline for comparisons between AFIT 1 and AFIT 2. Some valuable lessons were learned and some useful data was gathered, even though the HE-RPA development team was not able to fly AFIT 2.

V. Conclusions and Recommendations

5.1. Chapter Overview

This chapter begins by revisiting the overarching research objectives and discussing the findings in order to provide a concept evaluation for the HE-RPA and inform a decision maker. An evaluation is then made on the tailored SE approach and its application in this effort. Finally, recommendations for future work are discussed.

5.2. Research Objectives

5.2.1. Does current HE technology exist as a viable option for a small RPA in a military application?

Current HE technology has not yet developed sufficiently to be reliably used in small military RPA operations. As captured by Ausserer [12], the prototype HE-RPA developed as part of this research required a high level of detailed system knowledge in order to get all of the components functioning properly prior to flight test. Although bench and ground testing were deemed successful, the HE-RPA failed to demonstrate its potential capabilities in flight due to hardware failures unrelated to the HEPS.

Additionally, ground and technical support requirements for the prototype HE-RPA far exceed the man-portable/ATV transportable RPA system presented in the CONOPs.

Human system integration efforts were not a priority for this effort, making the HE-RPA system suboptimal as a useful military capability. Other problematic issues such as EM/ICE alignment and EMI were also observed. However, the technology is mature enough to warrant further investigation and development as a partial solution to the aforementioned capability gap.

5.2.2. *Is an airframe optimized for an HEPS airworthy?*

Based on the bench testing, taxi testing, and flight testing of AFIT 1 in restricted air space, the basic airworthiness of the airframe has been established. Specifically, the 12-ft wingspan configuration at the nominal weight of 35-lbs was flown successfully with acceptable performance. An integrated autopilot system was able to successfully control and navigate the airframe. The AFIT 1 flight tests also confirmed an efficient design with a predicted loiter time exceeding 7 hours. Although it was not the fully optimized configuration presented by Harmon [11], it is believed that a configuration closer to the optimized design would only enhance the performance. Successful flight tests will be required prior to airworthiness certification in other than restricted airspace.

It was observed in ground testing that EMI resulting from integration of the HEPS would result in uncontrollable conditions in flight. The EMI caused servo motors controlling the throttle and the control surfaces to exhibit excessive un-commanded movements. This issue is identifiable prior to HE-RPA flight and could be resolved in the future with additional wire shielding or rerouting of internal wires.

A critique on airframe robustness is also warranted. While, the airframe geometry proved airworthy, the construction materials and assembly techniques lacked robustness for any purpose other than a prototype airframe. Specifically, the wing and aft fuselage attachment technique relied on an aluminum hinge-pin configuration sandwiched between a fiberglass and foam inner and outer fuselage. This resulted in a weakened fuselage structure and repetitive realignment and repair issues. The hinge-pin design also

exacerbated flexibility issues within the structure and made it more difficult than warranted to access internal components

As demonstrated in taxi test but not flight test, the dual ICE and EM design provides an inherent airworthiness advantage. If one propulsion component malfunctions, the other could be used to safely land and recover the aircraft. This potential does not exist for an RPA with a single propulsion system.

5.2.3. Can an HE control strategy be developed and implemented into the RPA?

Two potentially viable control strategies were developed but not demonstrated for the HE-RPA. The first relied on a self-contained PIC32 microcontroller implementing custom control logic. The second relied on custom throttle split code implemented via the Virtual Cockpit software and Kestrel autopilot. Further testing is required to verify that the chosen control strategy is acceptable. The control logic for the flight control surfaces does not change between the ICE-RPA and the HE-RPA. The key difference is that the HE-RPA has several different throttle modes that were demonstrated during bench testing and taxi testing but have yet to be shown in flight test. Based on the bench and taxi testing results, it is reasonable to assume that if the HE-RPA has enough thrust to get airborne, then the control strategy will work for all throttle modes that command enough thrust to keep the HE-RPA airborne.

5.2.4. Can an HE system can be successfully integrated into a small RPA?

The current research demonstrated that the HE system can be successfully integrated into the RPA. The current research demonstrated one alternative to integrating

an HE system into an RPA and discussed several alternative methods. An alternate microcontroller could also be developed and used to automate the HE mode control. Additionally, an electric starter could be integrated into the system to support aerial restart of the ICE.

5.2.5. Does an HEPS improve RPA flight endurance over an RPA equipped with a non-HE system?

This effort was not able to successfully demonstrate that the endurance of an HE-RPA exceeds that of an RPA with a non-HEPS. Glasscock [23] proposed that an HE-RPA could be built with an electric motor that is designed to be used only during takeoff to decrease the required size of the ICE. Such an RPA could conceivably fly longer than an RPA powered by an ICE. Further research is required to determine the potential of such a system.

An HEPS could be used to exceed the flight endurance of the traditional ICE powered RPA if a control scheme that keeps the ICE throttle position constant during cruise and uses an EM to make the minor adjustments required to maintain steady level flight. Such a capability, referred to as the EM driver (EM boost) mode was successfully implemented and demonstrated during bench and ground testing of AFIT 2. The key difference between this recommended configuration and the configuration implemented on AFIT 2 is that it would have fewer batteries. AFIT 2 used several batteries because the intent was to develop a near-silent loiter capability with a greater dependence on EM operation. If the intent were to increase the duration of the cruise mode, then the ICE throttle position would be set at the optimal position and any excess power generated

would be used to recharge the batteries and any additional power required would be provided by the EM. Further research is required to determine the potential of such a system.

5.2.6. Does the HE system results in a reduced acoustic signature?

A reduction in the HE-RPA acoustic signature was not sufficiently demonstrated. Further research is required to determine the potential reduction in acoustic signature by the HE-RPA. The intent was to gather baseline in-flight acoustic data using AFIT 1 and then compare the results to in-flight acoustic data collected using AFIT 2 (the HE-RPA). However, the in-flight acoustic data collected from AFIT 1 was deemed invalid due to excessive wind noise. Additionally, acoustic testing of AFIT 2 did not occur due to an aircraft failure during takeoff. Acoustic testing conducted on the ground with AFIT 1 did identify a potential reduction in the acoustic signature of any RPA, not just the HE-RPA, by using an appropriately sized carbon fiber or equally stiff propeller with a higher blade count.

5.2.7. Does the HE-RPA meet capability requirements set forth in a CONOPS?

The capability requirements set forth in the CONOPS currently include:

- Austere Employment Capability;
- Effective Multi-Mode Operation;
- Rapid Ingress and Egress Capability;
- Minimally Complex Operator Interface;
- Sustained Near-Silent Loiter Capability;
- Adaptable ISR Payload Capability.

Currently, the “as-built” configuration represented by AFIT 2, lacks the capability to be employed in an austere environment. The HE-RPA does not currently possess the robustness, transportability, or minimal logistical footprint required for austere employment.

The rapid ingress and egress capability is tied to ICE only operation per the HE-RPA CONOPS. Flight tests conducted with AFIT 1 and bench testing conducted with AFIT 2 indicates that the HE-RPA does possess the necessary ICE reliability, controllability, and airframe performance necessary to achieve this capability. The HE-RPA also has the potential to perform a faster ingress or egress as required by operating in dual mode.

Bench testing indicated that the HE-RPA has the potential to sustain near-silent loiter operations via employment of the regeneration capability. Mode switching between the ICE only mode, EM mode with an idle ICE, and the regeneration mode was successfully demonstrated. However, without a mid-air ICE restart capability the ability to operate in pure EM only mode and transition into any other mode was not demonstrated. Currently, the “as-built” configuration would only partially meet this capability. While not quantitative, the acoustic measurement flight test with AFIT 1 did indicate that the HE-RPA has the potential to operate with a near-silent loiter capability at specific altitudes even with noise associated with the ICE. The EM only mode would serve to enhance the capability.

Ground testing and bench testing with AFIT 2 demonstrated the mode switching capability of the HE-RPA. Although the prototype lacked the ICE engine restart

capability and hence the ability to switch out of EM only mode, the mode switching logic implemented via the Virtual Cockpit ground station software, the Kestrel autopilot, and the electric motor control operated reliability with only minor operator induced problems. The more capable and self-contained implementation of the PIC32 microcontroller could further enhance the capability and reduce operator workload, better satisfying the desired capabilities in the CONOPS.

Even though the prototype HE-RPA operator interface GUI was an unplanned addition, the interface remained relatively simple and would meet the intended capability set forth in the CONOPS. The tested configuration only required the operator to click a set of radio buttons to switch between operational modes. As part of the development effort, an additional set of boost mode throttle settings were implemented. These would not be needed on an operational configuration. In the “as-built” configuration, the HE mode selection would ideally be transparent to the operator.

The CONOPS presented a requirement for an HE-RPA that could operate with a myriad of ISR payloads. The AFIT 2 configuration intended for flight testing had a gross weight of 35-lbs, which was determined to be the airframe limit on AFIT 1. Although the prototype HE-RPA only had capacity for a small payload, the power distribution and regeneration capability of the HEPS would facilitate the use of numerous payloads. Robust airframe construction allowing for the optimized 15-ft wingspan and 50-lb gross weight would leave considerable margin for numerous payloads. The HE-RPA concept could successfully fulfill the ISR payload capability.

In total, this effort focused on rapidly developing an HE-RPA prototype in order to evaluate it against a CONOPS. As built, the HE-RPA failed to demonstrate any of the in-flight capabilities set forth in the CONOPS. However, bench testing and ground testing confirmed that the HE-RPA does possess some of the desired non-flying specific capabilities. Successful bench and ground testing with the HE-RPA indicate that the system has the potential to satisfy a majority of the capabilities. With additional time to implement the design enhancements noted by Ausserer [12] and development of a robust variant of the airframe, the full set of capabilities could be achieved.

5.3. Evaluation of Tailored Systems Engineering Process

Using a streamlined SE process, the HE-RPA development team was able to rapidly develop a new airframe prototype with two very different propulsion systems in 13 months. The streamlined systems engineering process assisted the team in appropriately executing and scoping the project while maintaining visibility of high level project objectives given predicted and unpredicted project risks.

By tailoring the SE process as the project continued, the team was able to accomplish three objectives, each with a moderate to high level of technical risk. The team was able to develop and fly a new airframe, develop an HEPS, and integrate an HEPS into a new airframe.

The HE-RPA development team initially discussed creating a SEP by filling in the blanks of an existing SEP template but determined that a generic template would neither provided added value to the project, nor aid in the development of a useful tailored SE process. Instead, the team decided to initially start with an informal SEP

consisting of two bulleted lists and a simple schedule. The informal SEP was sufficient to scope and direct the work during the early stages of the project. As the project continued, formal documents such as the TEMP were added as deemed necessary until the SEP transformed into what became Chapter III of this thesis and the associated appendices.

The tailored SE process used and advocated in the current research did not include completing SE documents for the sake of completing SE documents, or as a means to convince a higher authority that the project was in good standing and that the team members were using good SE discipline. If the team were required to develop every SE artifact required for acquisition by the DoD , there would have been much less time to dedicate to project execution. The process also did not include hiring support contractors to complete SE documentation. A lack of SE knowledge and discipline within the team could not have been remediated by either hiring a contractor to accomplish all of the SE documentation required by the DoD or by filling in existing SE templates.

The principles of maintaining an SE approach that is event driven, has well defined entry and exit criteria, uses only SE artifacts that add value to the project, and allows a formal and informal format for SE artifacts proved useful and sufficient for tailoring the SE process to a rapid prototype development project.

5.4. Information for a Decision Maker

Ultimately, efforts such as the presented rapid prototype development and concept evaluation of the HE-RPA would be presented to a decision maker. A decision maker

would need a clear understanding of the current development status, required effort remaining, and potential benefits. In order to make a decision on the continuation of development efforts for the HE-RPA, the following questions were established at the project's inception and answered throughout prototype development and concept evaluation.

5.4.1. What additional efforts are needed to get to the “as intended” configuration?

Captured by the SV-8, Appendix F, in the systems architecture, the remaining effort required to get to the “as-intended” configuration consists of refined development and reliability enhancements of the HEPS and robustness enhancements to the airframe. Additionally, operationally representative systems would need to go through a battery of operationally representative tests in order to verify operability by standard users and a realization of military or commercial benefits.

5.4.2. What are the technology gaps?

The primary technology gaps are captured by Ausserer [12] and include limited capabilities of electric motor controllers and propeller and acoustic measurement and reduction efforts. While not a technology gap, the required fabrication tolerances of the HEPS would need to be fully understood by future HEPS developers.

5.4.3. How effective will it be?

While no HE-RPA system performance was demonstrated in flight, bench and ground testing of AFIT 2, along with flight test results from AFIT 1 indicate that a robust system with similar performance could fulfill the 2 to 8-hour capability gap that currently

exists between electric powered RPAs and gasoline/diesel powered RPAs. The power distribution of the HE-RPA, AFIT 2, could potentially also accommodate a myriad of ISR sensors. Additionally, results indicate that AFIT 1, equipped with a quiet propeller, may also provide the anticipated endurance and acoustic benefits of the AFIT 2 with lower risk and reduced complexity.

5.4.4. Will it provide military utility?

A robust and transportable variation of the system could provide military utility by reliably fulfilling the previously identified capability gap.

5.4.5. Who are the users and stakeholders?

As captured by the systems architecture, the users of the HE-RPA system would be the operators and support crew personnel. Stakeholders would be recipients of the collected ISR data such as a field unit or members of a command and control function.

5.4.6. Where could this concept be used successfully?

Although the efforts presented herein primarily focused on the military application presented by the CONOPS, an RPA system with the anticipated endurance and near-silent loiter capabilities of the HE-RPA developed as part of this research could be used for several other missions. Missions such as homeland defense, border patrol, agricultural health surveillance, law enforcement, and oceanic surveillance could benefit from use of the HE-RPA.

5.5. Recommendations for Future Work

More research and development is required to fully evaluate and quantify the concept of using an HE-RPA to fill the existing military capability gap discussed in Chapter I. The SV-8 depicted in Appendix F could be used to develop the “as-intended” configuration. If capability trade space is needed to get to the “as-intended” configuration, then the system functions identified in Table 3 should be examined. The HE-RPA development team was unsuccessful in demonstrating the capability of the HE-RPA to fly due to damage to AFIT 2 caused during takeoff. However, component and system performance demonstrated on the ground and on the bench, along with baseline airframe flight testing, indicate that the development of a fully capable HE-RPA system is attainable in the near future.

This team development effort expanded the HE-RPA body of knowledge. However, the HE-RPA concept is still in its infancy and requires further development to determine the military suitability of the different HE modes, configurations, and control schemes. In addition to further development of the HEPS and a robust airframe, further research is required to reduce the acoustic signature of propellers suitable for the small HE-RPA concept.

Further pursuit of the near-silent loiter capability would require research aimed at comparing results of acoustic measurements gathered from the HEPS in the lab environment to acoustic measurements gathered from an HE-RPA in flight. The purpose of this research would be to determine the ability to predict acoustic flight results based on acoustic data gathered in a lab environment.

One aspect of this research was to conduct a comparative acoustic analysis between AFIT 1 and AFIT 2. Comparisons between AFIT 1 and AFIT 2 would not be meaningful outside the scope of this research due to general inconsistencies in measuring dynamic acoustics in a universally accepted way. The use of an SPL meter and the A-weighting scale to measure dynamic RPA systems or propellers is questionable given the origination of this measuring technique. Without commonly employed and accepted standards for measuring acoustics, it would be difficult to compare the acoustic noise of AFIT 1 and AFIT 2 with other aircraft not included in this research. An investigation into acoustic measuring standards and techniques should be undertaken.

5.6. Summary

By following a tailored SE process, the HE-RPA development team was able to rapidly design, develop, and evaluate a prototype HE-RPA and a baseline ICE powered RPA. The development team was able to accomplish a majority of the objectives established during the initiation of this research. The team was able to demonstrate the potential of the HE-RPA in fulfilling the current endurance and logistical capability gaps that exist between the employment of electric powered RPAs and fossil fuel powered RPAs. The team was not able to accomplish all of the desired test events, but was able to accomplish a vast majority of test events by first accomplishing low risk test events. Further research in the area of HE-RPA development is required to demonstrate the potential of the “as-intended” configuration discussed in this research. Further research is also required to mitigate the acoustic signatures of RPA propellers.

Appendix A. Concept of Operations

HYBRID-ELECTRIC RPA

CONOPS



19 July 2011

Section I - Issue

A. Problem Statement

In the past decade, the US Military and Department of Homeland Security have seen the numerous benefits, and have come to rely upon, Remotely-Piloted Aircraft (RPA) and their role in combat and information operations. Fixed wing platforms such as the Predator (MQ-1)/Reaper (MQ-9) and the Global Hawk (RQ-4) have tremendous capabilities but they are low-density/high-value (LDHV) assets; making their availability limited to all but the most critical missions. As a result, there has been rapid growth in the area of smaller, unit controlled, RPAs. These are small (less than 30 lbs) to medium (between 30 and 500 lbs) sized air vehicles capable of being operated by small forward deployed units. These vehicles provide critical Information, Surveillance, and Reconnaissance (ISR) data before, during, and after ground operations.

However, there are two critical issues that limit the usefulness of these small to medium sized RPAs. In order to achieve a desired standoff capability or a long endurance/loitering capability, the vehicles must be equipped with an Internal Combustion Engine that burns gasoline or diesel fuel. These fuel burning engines are both noisy to operate and cumbersome to support during combat operations; limiting their use at low altitudes and often requiring dedicated support facilities. On the other hand, smaller battery powered electric RPAs are considerably quieter and more efficient in their energy utilization. In general, they are more portable, easier to operate, require less support and maintenance, and can be flown at lower altitudes. The drawback is their limited endurance and limited payload; requiring their employment considerably closer to the target area than their fuel burning counterparts. The challenge is to create and utilize an RPA with the endurance benefits of an internal combustion powered vehicle but with the reduced acoustic signature, reduced logistic support, and low altitude operations of an electric powered vehicle.

B. Overarching Vision

To deliver timely and relevant ISR to forward deployed ground based units via the use of a remotely-piloted aircraft encompassing the benefits of both fuel burning and electric powered remotely-piloted air vehicles while operating from a safe standoff location.

C. Purpose of the CONOPS

This document describes operational employment scenarios whereby military or homeland security personnel could realize the unique endurance and acoustic benefits offered by a remotely-piloted aircraft (RPA) powered by a hybrid-electric propulsion system. The system utilizes an integrated semi-autonomous propulsion control strategy to maximize mission effectiveness. A common command, control, and communications interface will be utilized, enhancing the system flexibility and making the system adaptable to a wide variety of situations and environments. The system will have a versatile payload configuration allowing for multiple ISR configurations or unique payload employment.

D. SCOPE

This document is intended to be a [Joint Component] Enabling Concept and is written at the operational-level. This document supports the fundamental guidance and overarching concept for NATO operations detailed in the Strategic Concept of Employment for Unmanned Aircraft Systems in NATO 2010.

Specifically, the Hybrid-Electric RPA CONOPS will describe the anticipated utilization and supporting context required to sustain persistent and covert RPA operations detailed in the United States Air Force Posture Statement 2011 for Global Integrated Intelligence Surveillance Reconnaissance (ISR).

Section II – Overview

A. Synopsis

A hybrid-electric powered RPA will provide forward deployed ground based units the capability to conduct sustained, low altitude, ISR operations from a safe standoff distance with minimal logistical support. Specifically, the use of the hybrid-electric RPA will allow operators to:

- *Rapidly setup and deploy RPA system from austere location*
- *Quickly ingress/egress to/from the target area utilizing internal combustion engine*
- *Covertly loiter over a desired target area using electric power*
- *Utilize payloads optimized for low altitude operations*
- *Monitor ISR data from safe standoff distance*
- *Regenerate electrical stores for sustained surveillance operations*
- *Provide timely ISR data for ongoing/future ground operations*

B. Operational View (OV)-1

The following figure depicts the overall environment and operational phases described in this CONOPS. In order to achieve outcomes defined by the vision statement using a hybrid-electric RPA, the following actions are necessary.

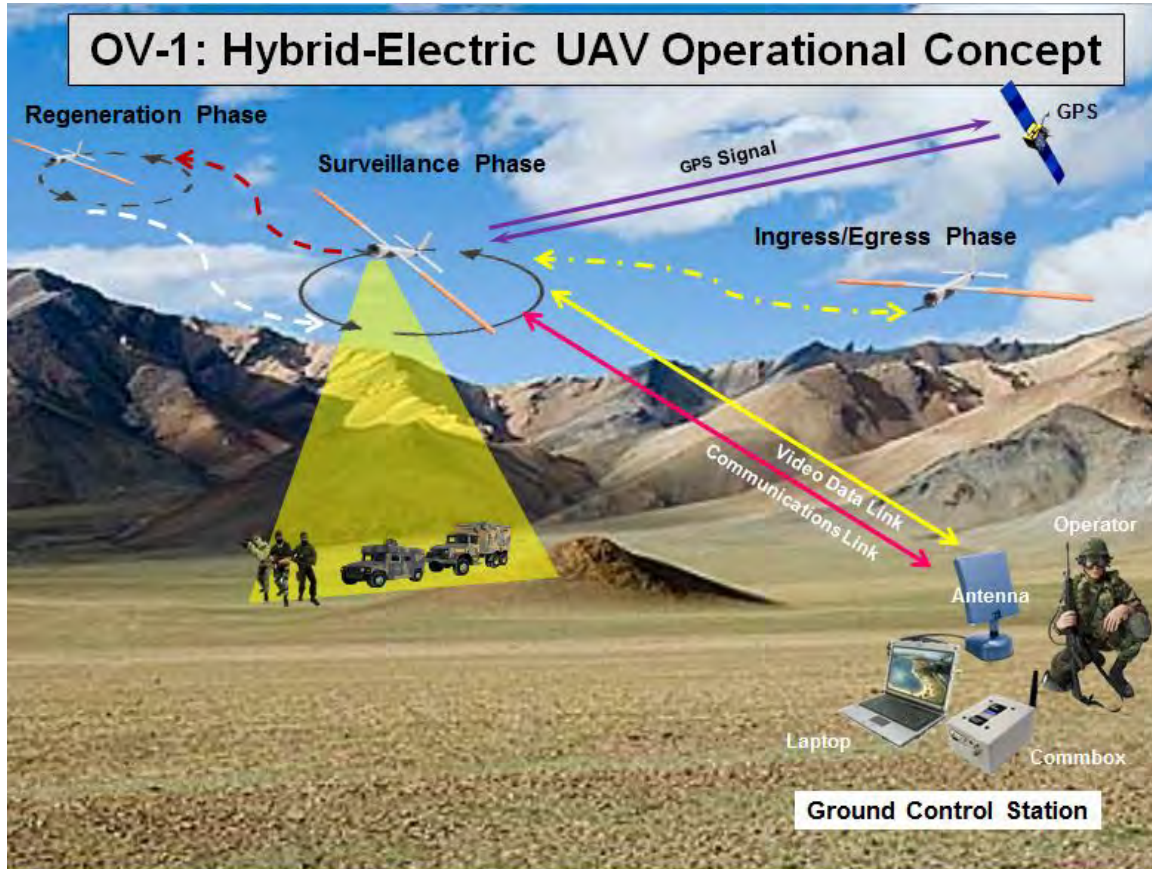

Ground Control Setup & Teardown Phase: This phase encompasses all actions necessary to deploy the hybrid-electric RPA system including: unpacking, inventory, assembly, function checks, mission planning, and launch and recovery.

Ingress/Egress Phase: This phase utilizes the hybrid-electric propulsion system, operating in a cruise mode, to quickly transition to-and-from the launch location to the target area. The cruise mode takes advantage of the benefits offered by the internal combustion engine (ICE) to efficiently and rapidly reach the target area when the additional noise of the ICE will not be a detriment to the mission.

Surveillance Phase: This phase utilizes the hybrid-electric propulsion system, operating in an endurance mode, to acquire surveillance data within the target area while minimizing its acoustic signature and thereby the probability of detection. The endurance mode utilizes the battery powered electric motor capability to loiter over a target area without the elevated noise levels produced by the ICE.

Regeneration Phase: This phase utilizes a unique regeneration capability offered by the hybrid-electric propulsion system. The primary mission of the RPA is to acquire ISR while over the target area. However, this requires prolonged operation in the endurance mode and to date, current battery technology does not support the desired mission needs. The regeneration mode allows the HE-RPA to transition to an area (or altitude), where the noise level of the ICE does not impact the mission, and to utilize the electric motor, now acting as a generator, to recharge the battery packs. This capability allows for prolonged mission times without having to recover back to the ground control station for battery replacement.

External Environment: The hybrid-electric RPA will generally operate in austere and hostile environment under a myriad of environmental conditions. The operational environment must be capable of providing a global positioning system signal as it will be the primary navigation aid for the HE-RPA. Operational employment may be dependent upon terrain obstacles and/or operational altitude as the primary human-to-vehicle communication pathway will be a high-frequency radio signal. Line-of-sight limitations will have to be accounted for in mission planning.

C. Description of Military Challenge

Currently, minimally detectible assets capable of collecting persistent ISR are high-value low-density systems. Forward deployed units desire the benefits provided by these assets but the units are limited by availability and instead, must rely on currently available gasoline/diesel or electric powered RPAs. The hybrid-electric RPA is intended to fill a gap that exists between the performance benefits of gasoline/diesel powered RPAs and electric powered RPAs, while still providing the desired ISR collection capability. The hybrid-electric RPA is intended to conduct missions currently ill-suited for either gasoline/diesel powered RPAs or electric powered RPAs. The primary objective of the hybrid-electric RPA is the collection of timely ISR data with a low probability of detection by forward deployed, ground based operators, while maintaining a safe standoff distance from the target area.

D. Desired Effects

The desired effect is to provide ground based units with undetected, timely, and enduring ISR data from a safe standoff distance with minimal logistical support.

Section III – Context

A. Time Horizon

This CONOPS focuses on an enabling capability intended to provide ground based units with ISR data in support of theater directed mission taskings. This CONOPS provides employment recommendations for a proposed hybrid-electric RPA [system]. Through expanded operation and utilization, the recommendations provided are intended to evolve into strategic employment scenarios as best practices are collected and documented. The planned initial utilization begins in FY12 and proceeds into the foreseeable future.

B. Assumptions

This CONOPS assumes that the capability gap identified between high-density low-volume ISR assets, gasoline/diesel powered RPAs, and electric powered RPA is still present and unresolved. Additionally, it is assumed that airspace deconfliction issues will be resolved prior to each mission utilizing the hybrid-electric RPA as there is no intent to address that specific issue within this document.

C. Risks

The following risks were derived from a consortium of stake holders including, former RPA operators, systems architects, subject matter experts, system designers, and testers:

- *Loss of RPA due to hostile detection and action*
- *Loss of RPA due to broken communications link*
- *Loss of RPA due to system malfunction*
- *Loss of RPA due to extreme environmental conditions*
- *Hostile detection of operator location*
- *Hostile acquisition of signal feeds and/or control of RPA*
- *Loss of mission due to unreliability of system components*
- *Loss of mission due to system degradation*
- *Loss of RPA and/or mission due to lack of logistical resources*
- *Loss of RPA and/or mission due to lack of operator knowledge*
- *Injury to operator and/or noncombatants from system operation*

In response to the identified risks associated with system operation, the following risk mitigations were derived:

- *Prototype development*

- *Spiral development process*
- *Relevant application of systems architecture and test management*
- *Thorough utilization of SE practices*
- *Development and evaluation of acoustic characteristics designed to mitigate RPA detection and loss*
- *Development of robust autopilot control strategy*
- *Evaluation and documentation of maximum employable range/altitude scenario*
- *Development and documentation of operators manual and emergency procedures*
- *Evaluation of environmental performance and development of recommend employment conditions/limitations*
- *Minimization of ground control and logistical support equipment*

Additionally, risks associated with system and signal security are deemed acceptable by stake holders and no associated mitigation actions are addressed. The anticipated results of risk mitigation activities are depicted in Table 1.

Table 14: Effects of Risk Mitigation

Risk ID	Risk Description	Preliminary Risk			Mitigation	Residual Risk		
		Effect	Frequency	Impact		Effect	Frequency	Impact
1	Loss of RPA due to hostile detection and action	Critical	Seldom	Low Risk	Prototype design and testing to evaluate detectability	Marginal	Seldom	Low Risk
2	Loss of RPA due to broken communications link	Critical	Occasional	Medium Risk	Development of robust autopilot capability	Critical	Seldom	Low Risk
3	Loss of RPA due to system malfunction	Critical	Occasional	Medium Risk	Spiral development to improve reliability	Critical	Seldom	Low Risk
4	Loss of RPA due to extreme environmental conditions	Critical	Seldom	Low Risk	Development of operational employment limits	Marginal	Seldom	Low Risk
5	Hostile detection of operator location	Catastrophic	Seldom	Medium Risk	Minimization of logistical support footprint	Critical	Seldom	Low Risk
6	Hostile acquisition of signal feeds and/or control of RPA	Catastrophic	Unlikely	Medium Risk	None	Catastrophic	Unlikely	Medium Risk
7	Loss of mission due to unreliability of system components	Critical	Occasional	Medium Risk	Spiral development to improve reliability	Critical	Seldom	Low Risk
8	Loss of mission due to system degradation	Critical	Occasional	Medium Risk	Spiral development to improve reliability	Critical	Seldom	Low Risk
9	Loss of RPA and/or mission due to lack of logistical resources	Critical	Occasional	Medium Risk	Minimization of logistical support footprint	Critical	Seldom	Low Risk
10	Loss of RPA and/or mission due to lack of operator knowledge	Critical	Seldom	Low Risk	Development of operational training materials	Critical	Unlikely	Low Risk
11	Injury to operator and/or noncombatants from system operation	Catastrophic	Seldom	Medium Risk	Development of operational training materials and emergency procedures	Critical	Seldom	Low Risk

Section IV – Employment Concept

A. High-Level Context

The high-level context that relates the hybrid-electric RPA concept to achieving strategic objectives is centered on its ability to provide useful ISR to operating units. A basic employment profile for the operational employment of a hybrid-electric RPA concept is depicted in figure 1.

For example, a military ground unit, with intelligence indicating a possible increase of insurgent activity in a nearby township, decides to evaluate the situation before proceeding with intervening actions. In this situation, high-value low-density assets (Satellite imagery, Global Hawk, or Predator RPA) are unavailable. Gasoline/diesel powered RPAs are noisy and may tip-off the insurgents that they are being observed but the quieter electric powered RPAs lack the range necessary to both ingress and egress to-and-from the target area and collect ISR data. From a safe undetectable distance, the hybrid-electric RPA could be quickly setup and deployed, flown to the area of interest, loiter and collect ISR with near-silent operation, regenerate battery capacity if prolonged near-silent operation is required, and then return for redeployment.

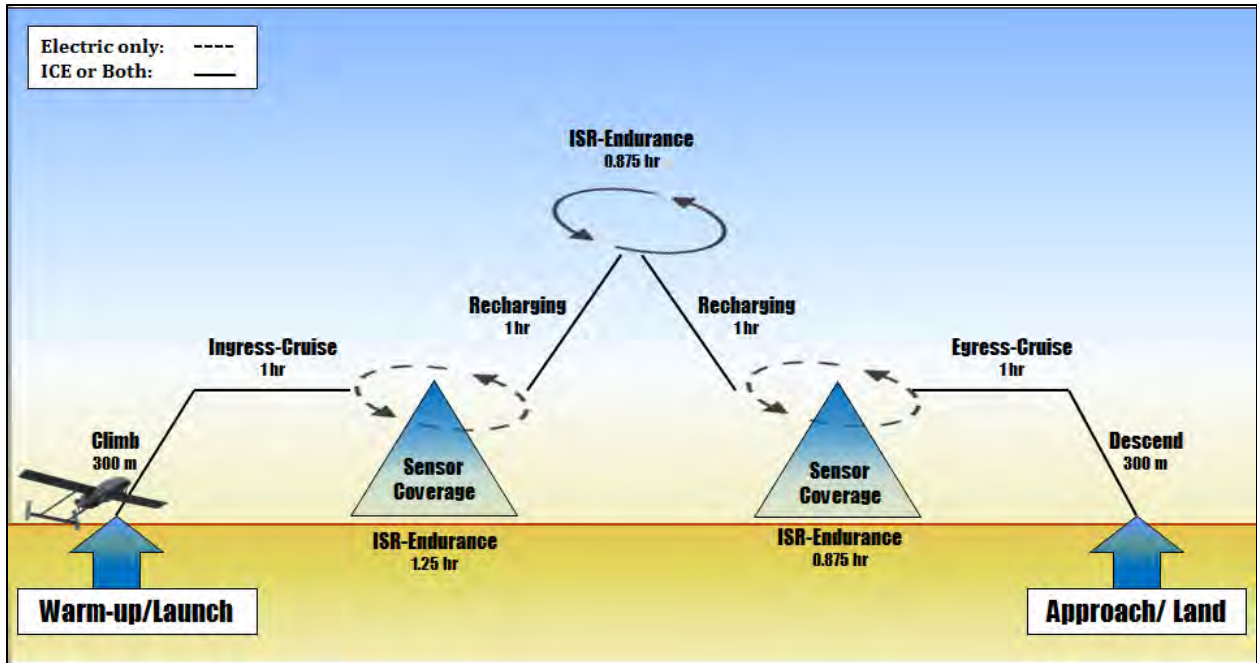

Figure 1: High Level Context, Segmented ISR

B. Critical Capabilities

The desired mission effects can only be realized by a hybrid-electric RPA if it possesses the following critical capabilities.

Austere Employment Capability: In order to achieve the desired effects, the hybrid-electric RPA must be deployable in numerous terrains and environmental conditions. The hybrid-electric RPA system will be transportable in a one-vehicle/ATV configuration and/or towable configuration. It may be further broken down into man-portable components. System design has been optimized for minimal fuel (gasoline) consumption. RPA can be launched and recovered with minimal clearance restrictions. A portable catapult launcher further enhances potential use in rugged environments.

Rapid Ingress and Egress Capability: In order to capture timely ISR information on potentially fleeting targets, the hybrid-electric RPA uses a multi-mode internal combustion engine (ICE) and electric motor propulsion system. Propelling the HE-RPA solely with the ICE shall provide sufficient speed to acquire most targets; however, additional speed may be delivered via additive power of the electric motor. To assure minimal chance of detection, the same mode can be used to egress from the target area.

Sustained Near-Silent Loiter Capability: The primary purpose of utilizing RPAs is in the collection of ISR data. In order to successfully fill the ISR gap that exists between low-density high-value assets, gasoline/diesel powered RPAs, and electric powered RPS,

a hybrid-electric RPA will have the capability to loiter over a target area for a sustained period of time with minimal probability of detection due to a reduced acoustic signature.

Effective Multi-Mode Operation: The hybrid-electric RPA possess capabilities allowing for multi-mode operation facilitating rapid ingress/egress and sustained near-silent ISR collection. Primary modes of operation include an ingress/egress (cruise) mode, a loiter (endurance), and a regeneration (recharge) mode. The HE-RPA allows for tailoring of mode selection criteria in order to meet specific mission needs.

Minimally Complex Operator Interface: An essential characteristic of the hybrid-electric RPA is focused on operation and control with minimal operator input. Multiple aspects of the operation employment scenarios will be controlled via an autonomous interface with manual override potential. The autonomous control strategies and initial design aspects of the hybrid-electric RPA will be implemented as specified in the system's architectural design, thereby reducing operator interface and control to essentially point-and-click control via the ground station.

Adaptable ISR Payload Capability: The hybrid-electric RPA will accommodate different ISR payloads with a configurable bay. Design considerations were taken to accommodate the electrical and structural needs of a multitude of sensors. The RPA is well suited to carrying ISR payloads designed for low altitude employment.

C. Enabling Capabilities

In order to support the critical capabilities, the hybrid-electric RPA requires a small set of enabling capabilities.

Access to Global Positioning Satellite Network: The hybrid-electric RPA relies on the global positioning satellite (GPS) for waypoint navigation. The hybrid-electric RPA cannot be deployed autonomously in areas with weak or denied GPS communication.

Logistical Support: As a component of the hybrid-electric RPA, the internal combustion engine requires a small amount of gasoline for sustained operations. The ground control station also requires battery power or generator support for sustained operations.

Effective Communication: Operators need the capability to relay information obtained with the hybrid-electric RPA to commanders, mission planners, or additional field units. The particular method is left to the operator's discretion.

D. Sequenced Actions

A hybrid-electric RPA system will be considered fully operational capable when a unit of operators can successfully transport, deploy, control, communicate, collect ISR data, recover, and maintain the RPA system.

The sequenced actions that will result in successful operational employment of a hybrid-electric RPA are shown below. The sequenced actions are segregated into anticipated mission phases.

Pre-deployment:

- **Mission Planning:** The need for employment and intended target areas need to be identified.
- **Logistics Planning:** Although minimal, the necessary logistics support needs to be pre-coordinated, especially for extended-missions
- **Sight Selection:** Suitable launch and recovery locations should be identified prior to launch. Recovery sight, if different from launch sight, should be given a security risk evaluation.
- **Communication:** Communication between operators and recipients of collected ISR data should be established to increase mission effectiveness.

Deployment:

- **Transport:** Hybrid-electric RPA system will be transported to launch sight. Method of transport will be dependent on specific mission scenario.
- **Site preparation:** Launch site should be evaluated for security and all potential obstacles should be removed

- **Inventory and Assembly:** Operators will ensure all necessary RPA and ground station components are present before launch. The RPA system will be assembled into desired configuration.

- **Operation Checkout:** Operations will perform functional checks on all equipment prior to launch in order to ensure safe operation and that RPA is mission capable. Operator will also establish communication between RPA and associated units.

- **Load Mission Profile:** Operator will upload preliminary mission plan (waypoints) as dictated per mission planning, to include multi-mode operations.

- **Vehicle Launch:** RPA launched either via ground rollout or catapult. Operation will consist of specific modes or phases as indicated below:
 - **Ingress/Cruise** – RPA utilizes Internal Combustion Engine (ICE) to close range to target area

 - **Loiter/Endurance** – RPA utilizes electric motor for sustained near-silent ISR data collection
 - **Monitoring and Collection of ISR:** Operators will monitor ISR feeds and/or data collection. Operators will communicate findings to necessary personnel.

 - **Monitoring of RPA Status:** Operators will monitor operational parameters of vehicle in order to ensure all systems are functioning correctly and RPA can continue with mission.

- **Update Mission Profile:** Mission requirements may change throughout duration of RPA flight. Operators will update mission profile via communications link as required.
- **Recharge/Regenerate** – RPA utilizes ICE to recharge battery stores for additional loiter/endurance operation
- **Egress/Cruise** - RPA utilizes Internal Combustion Engine (ICE) to exit target area and traverse to recovery location

Recovery:

- **Landing:** Upon return to recovery location, RPA will self-initiate a controlled stall landing or roll-out landing; specific method will be selected by operator.
- **Post-Flight:** Operator will inspect vehicle for damage and/or reconfigure for next flight
- **Disassembly and Packing:** Operator will disassembly RPA and ground station and re-pack into transport containers
- **Inventory and Transport:** Operator will inventory contents of transport containers and transport RPA to next location

E. End State

The end state will be achieved when the hybrid-electric RPA is capable of providing a sustained near-silent ISR collection capability by a forward deployed unit in order to meet mission requirements.

Section V – Summary

The benefits of utilizing Remotely-Piloted Aircraft in military and homeland security operations have been profound over the last decade. However, a capability gap has developed between the use of high-value low-density assets, gas/diesel powered RPAs, and electric powered RPAs. The hybrid-electric RPA possess the capabilities needed to

provide ISR coverage when high-value low-density assets are unavailable, gas/diesel powered RPAs are excessively noisy, and electric RPAs lack the necessary range/endurance.

This CONOPS details an employment concept for the utilization of a hybrid-electric RPA along with the system's critical capabilities, the required enabling capabilities, and a series of sequenced actions required to facilitate mission success. Although this CONOPS details a generic employment concept for a hybrid-electric RPA, the fundamental organization of mission elements and capabilities should be applicable to all similar system.

Appendix B. All Viewpoint 1 (AV-1)

Air Force Institute of Technology
HEV Architecture
Overview and Summary Information (AV-1)
March 31, 2011

This AV-1 is an executive-level summary of the Hybrid-Electric UAV architecture as a portion of an Office of the Secretary of Defense (OSD) funded project incorporated into theses for the Air Force Institute of Technology. This initial version of the AV-1 focuses the architecture development effort by documenting the scope and intended usage.

Architecture Project Identification

Name	Hybrid Electric Unmanned Aerial Vehicle (HEV) Architecture
Architect	Air Force Institute of Technology (AFIT)
Developed By	AFIT Students: Jacob English, Capt. USAF; Michael Molesworth, Capt. USAF
Assumptions and Constraints	The HEV architecture: <ul style="list-style-type: none">• Addresses an “as intended” and “as built” HEV configurations• Follows DoDAF guidance• Will be tailored to meet strict time constraints and program requirements• Document gaps and prescribe mitigation strategies
Approval Authority	Architecting activities will be approved by AFIT faculty advisors
Date Completed	March 31, 2012

LOE and Costs	<p>Level of effort will be consistent with similar USAF UAS DT&E initiatives.</p> <p>Efforts will be tailored according to the prescribed architecture in order to meet strict time constraints. Funding will be managed by AFIT faculty and limited to FY10/FY11 amounts.</p>
Products Developed	<p>HEV architecture consists of the set of integrated DoDAF architecture products -- AV-1, OV-1, OV-2, OV-5, SV-1, SV-4, SV-5, SV-8, SV-9, and SV-10; necessary to comply with DoDAF requirements and to distinguish between the “as intended” and “as implemented” configurations</p>
Scope	<p>The scope of the HEV architecture is to identify functions, processes, rules, data, or technology that is required in order to successfully develop and demonstrate the “as intended” concept and to identify the associated gaps when compared to the “as implemented” configuration; within the given time and budget constraints.</p>
Time Frames Addressed	<p>The HEV architecture could serve as the basis for a pre-developmental program decision process in order to support a desired system life-cycle beginning in FY 2012</p>

Organizations Involved	<p>Development of the pre-acquisition HEV architecture will involve organizations from the DoD as follows:</p> <ul style="list-style-type: none"> • Air Combat Command (ACC) and/or Air Force Special Operations Command (AFSOC) operational functionals for system requirement. • Air Force Material Command (AFMC) for safety requirements • Air Force Research Labs (AFRL) for flight authorization and test plan approval requirements • Air Education and Training Command (AETC) for AFIT MS program requirements • Financial Management/ Comptroller (to be implemented by AFIT cost analysis student)
-------------------------------	--

Purpose and Viewpoint	
Purpose	<p>The HEV architecture will provide a blueprint for vehicle development, gap analysis, and testing. It will also serve as a guide for future HEV development and/or verification and production of a system intended to provide an Enabling Concept for covert ISR operations for coalition unmanned air systems (UAS).</p> <p>The architecture will highlight key operational parameters valued by the warfighter and will serve as a guide in validating performance requirements. It will serve as a reference for system development, verification, and employment.</p> <p>HEV architecture will identify the capabilities needed to produce a persistent and covert, UAS based, ISR capability</p>

<p>Questions to be Answered</p>	<p>The following questions are considered critical to successful completion of the architecting effort. The HEV architecture should be capable of sufficiently answering the following:</p> <ul style="list-style-type: none"> • What additional efforts are needed to get to the “as intended” configuration? • What are the technology gaps? • How effective will it be? • How will effectiveness be tracked/measured? • Will it provide military utility? • Who will be in control of system? • Does current doctrine suffice or is new doctrine needed? • Is it easily exploited by enemy? • Who are the users and stake holders? • Where will this concept be used? Where will it be used successfully?
<p>Architecture Viewpoint</p>	<p>The HEV architecture is developed from a SysML based viewpoints in support of DoDAF V2.0.</p>
<p>Context</p>	
<p>Mission</p>	<p>The HEV is envisioned as an essential capability multiplier in the utilization of military ISR via the use of unmanned aerial systems (UAS) to extend the realized benefits of currently employed low-density high-demand ISR assets.</p> <p>An integrated system will be critical to the success of the HEV. Therefore, the development of a succinct architecture is essential and considered a critical aspect of the overall mission given the strict time constraints.</p>
<p>Goals</p>	<ul style="list-style-type: none"> • Describe a methodology for efficient and complete development of the envisioned system capable of fulfilling the HEV requirements. • Establish techniques for rapid but thorough concept evaluation • Support DoD’s decision making process for future system viability • Provide the foundation to accelerate system development and implementation

<p>Rules, Criteria, and Conventions Followed</p>	<p>Rules -</p> <ul style="list-style-type: none"> • HEV architectural products shall be developed and decomposed only to the level of detail required to adequately fulfill the envisioned CONOPS and answer the critical questions. <p>Criteria and Conventions – Guidance contained in DoDAF V2.0 and AP233 (SySML) will be followed to the greatest extent possible in order to facilitate future reuse of products and data.</p>
<p>Tools and File Formats Used</p>	
<p>Enterprise Architect v8.0, Microsoft; Word, Excel, Project, Adobe Acrobat</p>	

Appendix C. Textual Use Cases and Activity Diagrams (OV-5)

Diagram: Collect ISR Data

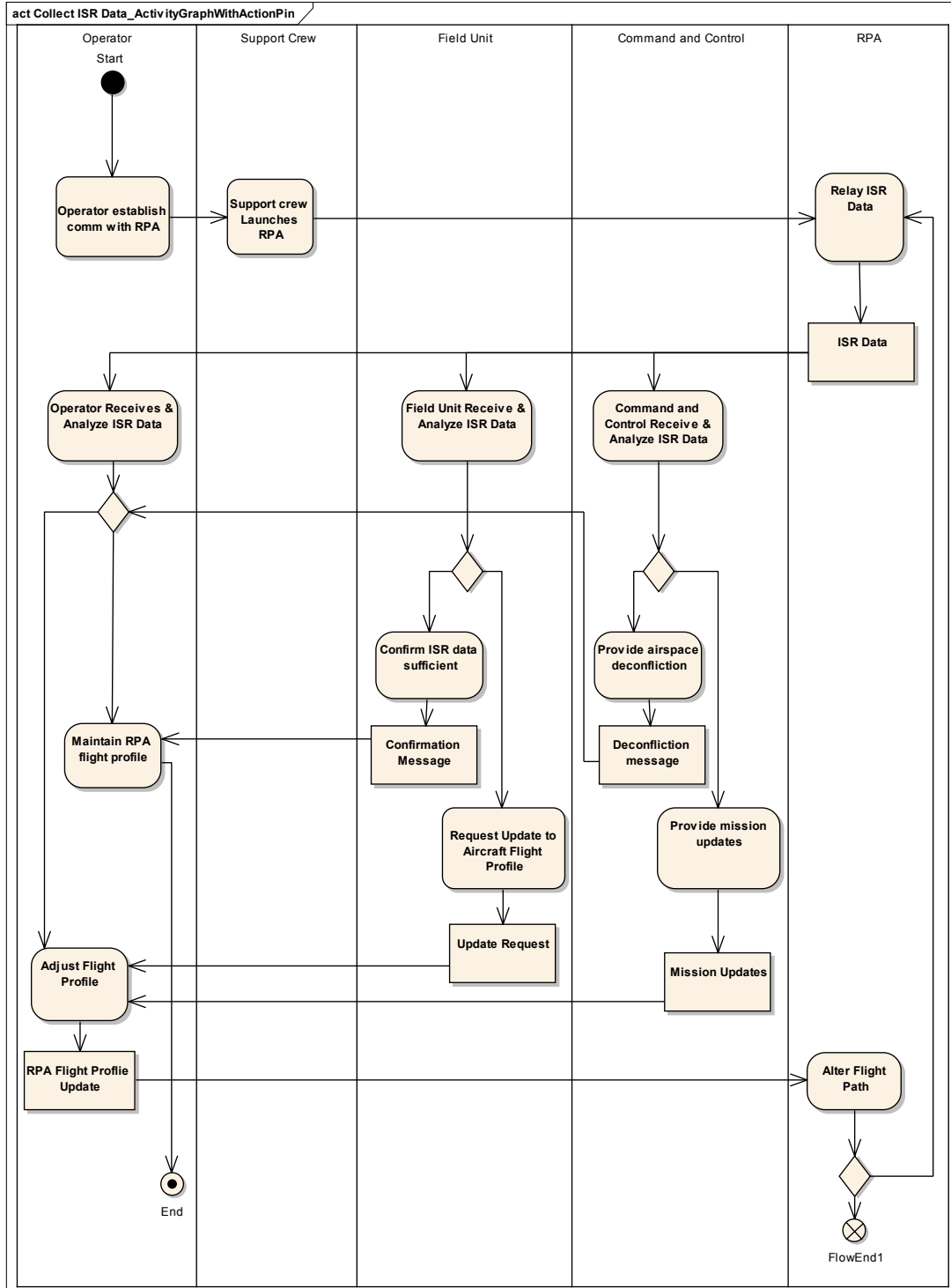

Diagram: Communicate with Dispersed

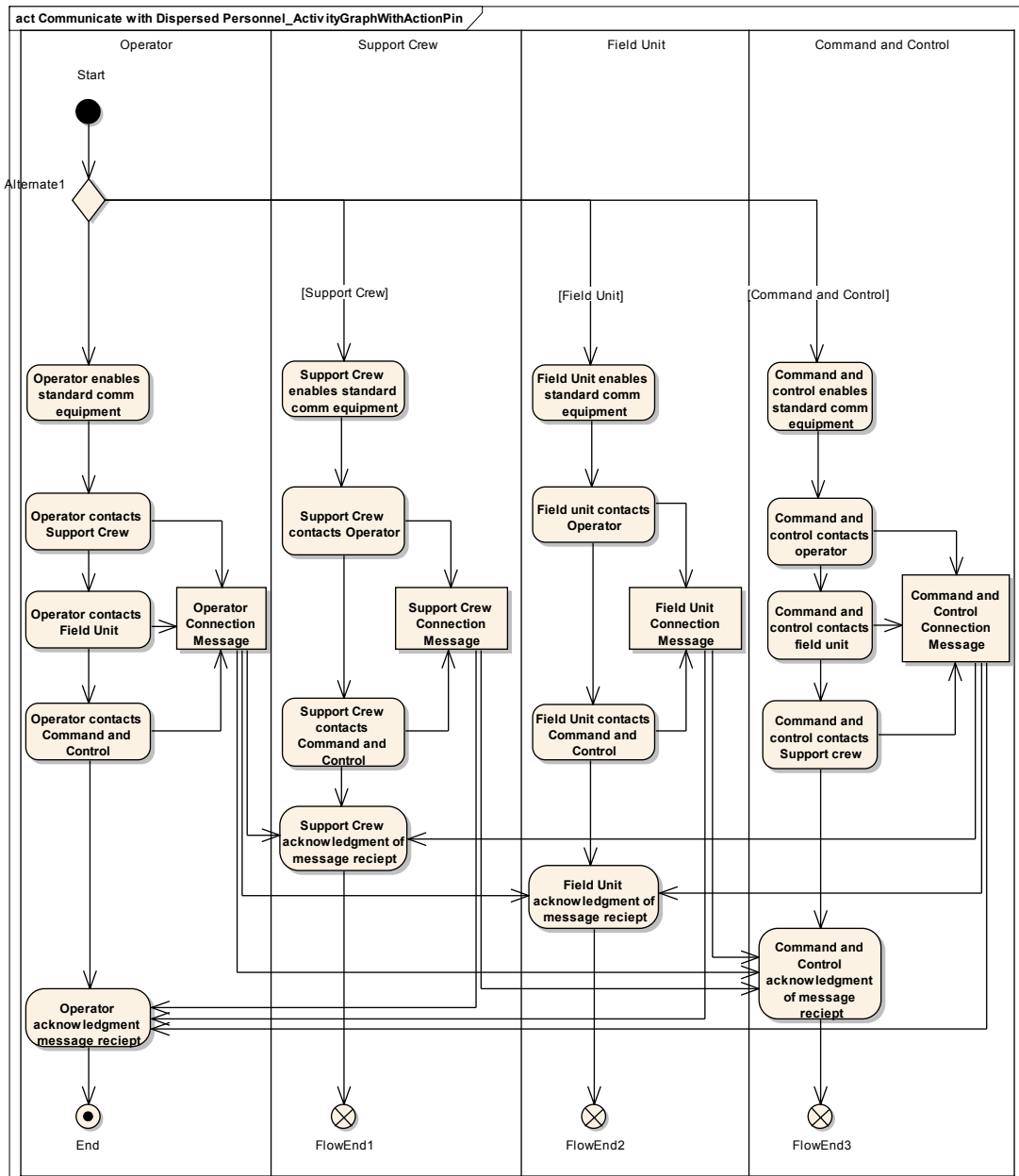

Diagram: Establish Comm

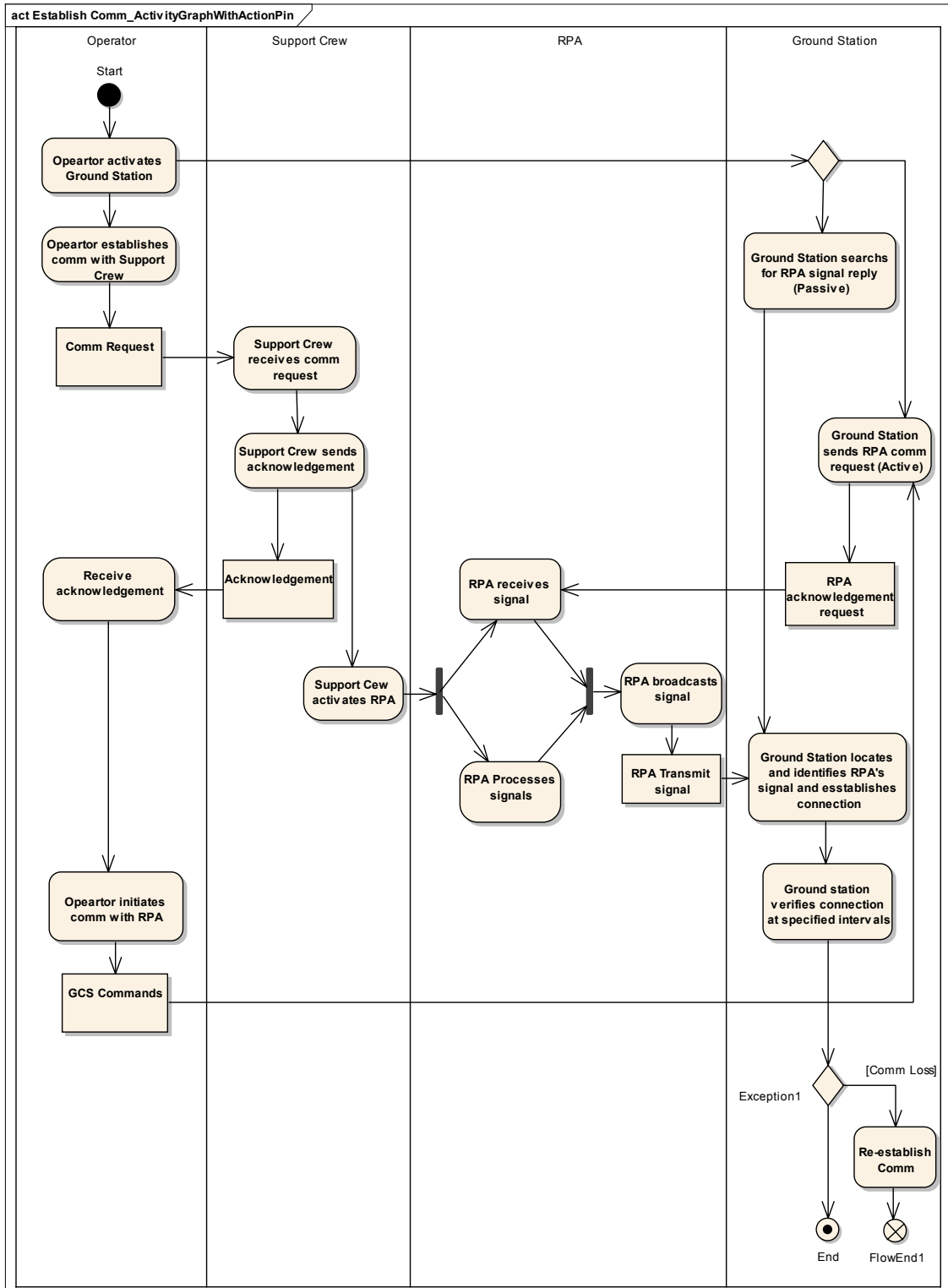

Diagram: Fly in Manual Mode

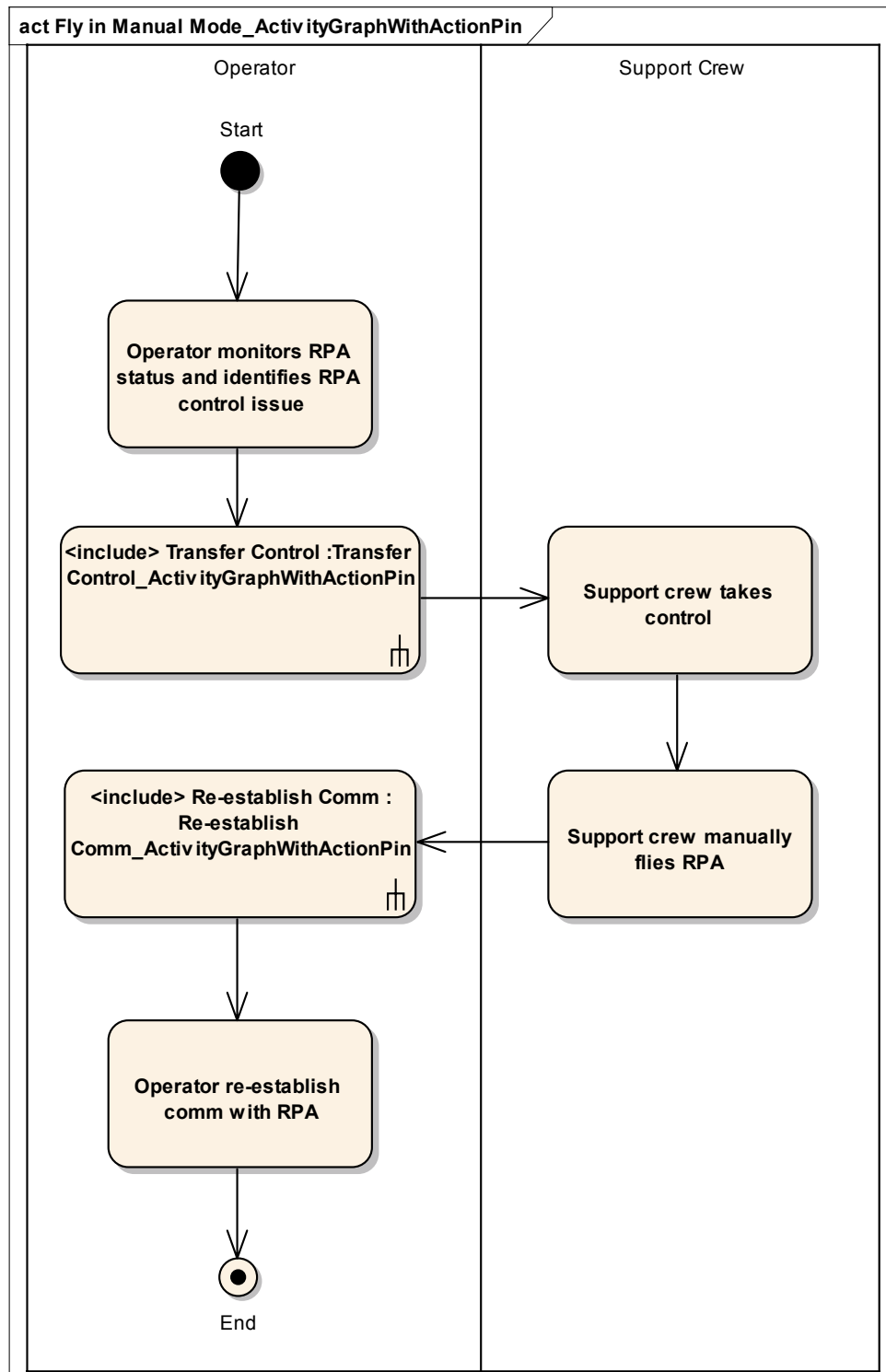

Diagram: Launch/Recover Aircraft

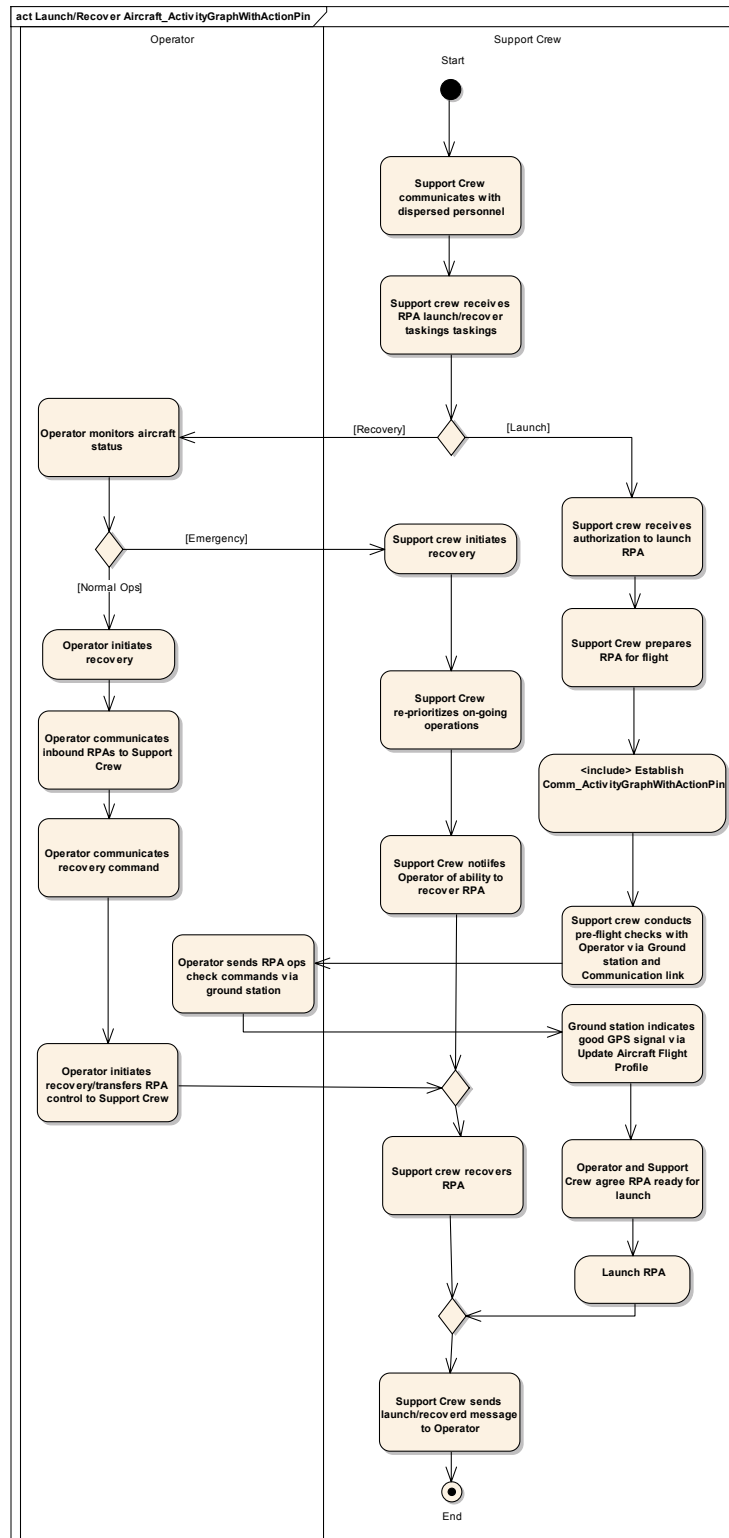

Diagram: Monitor Aircraft Status

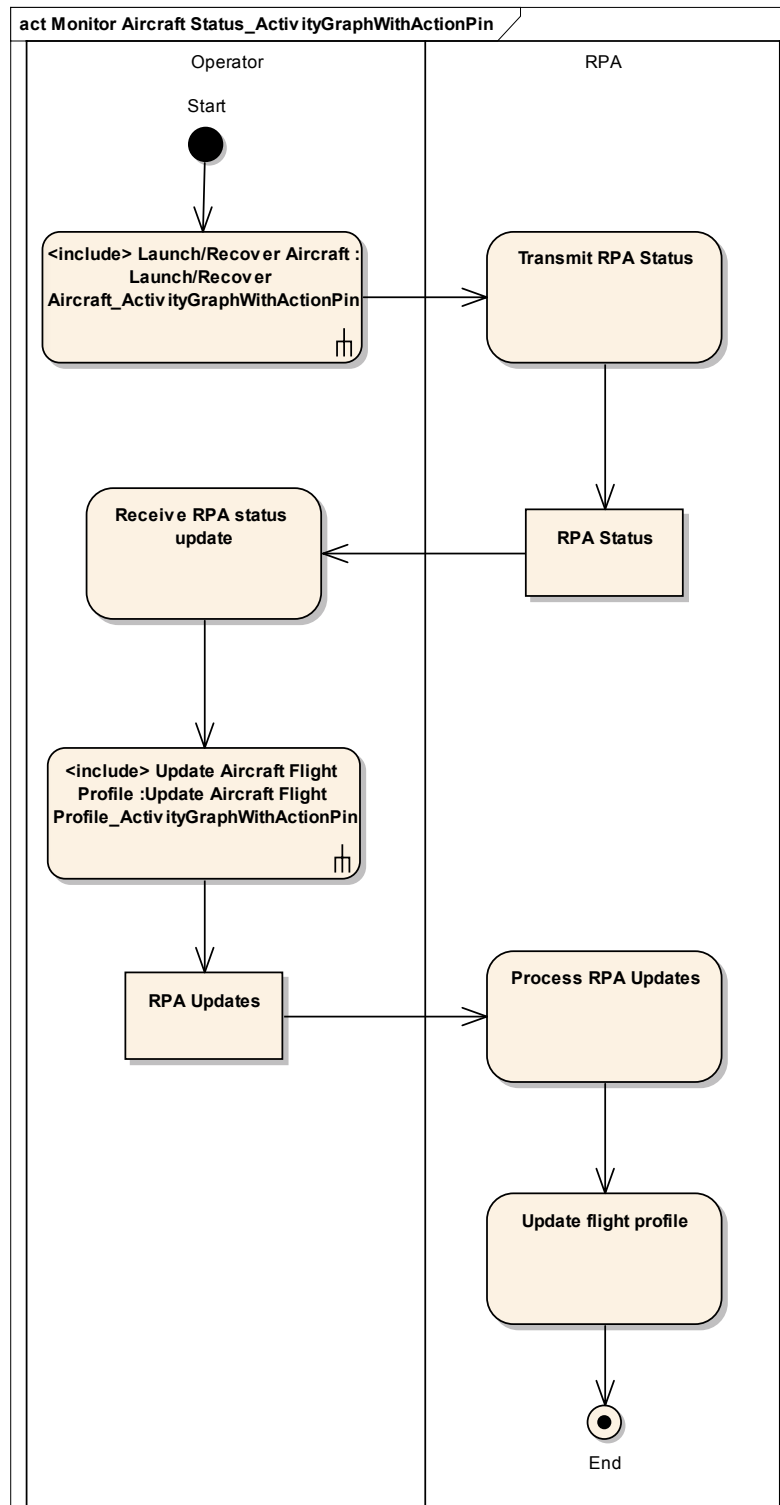

Diagram: Re-establish Comm

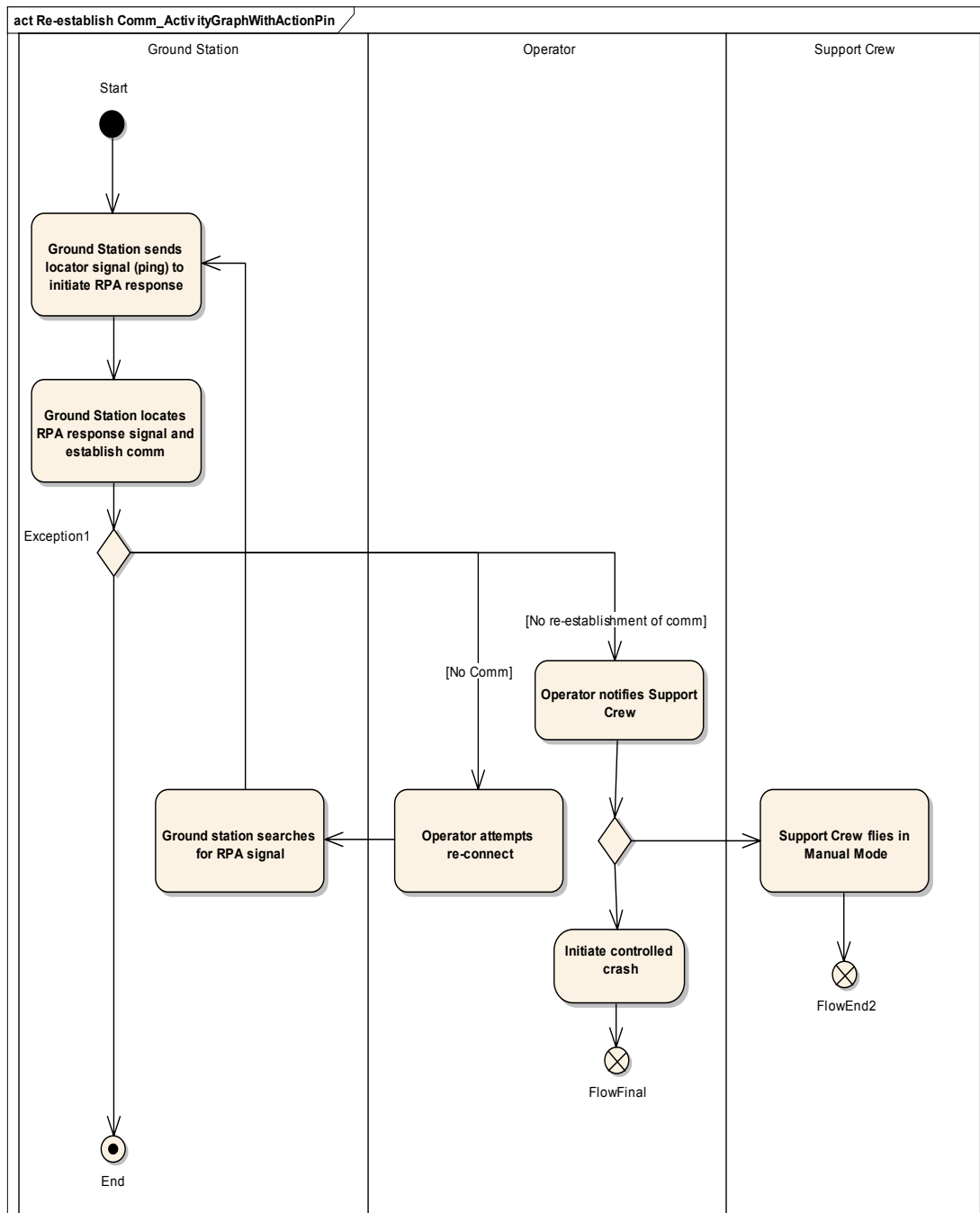

Diagram: Relay ISR Data

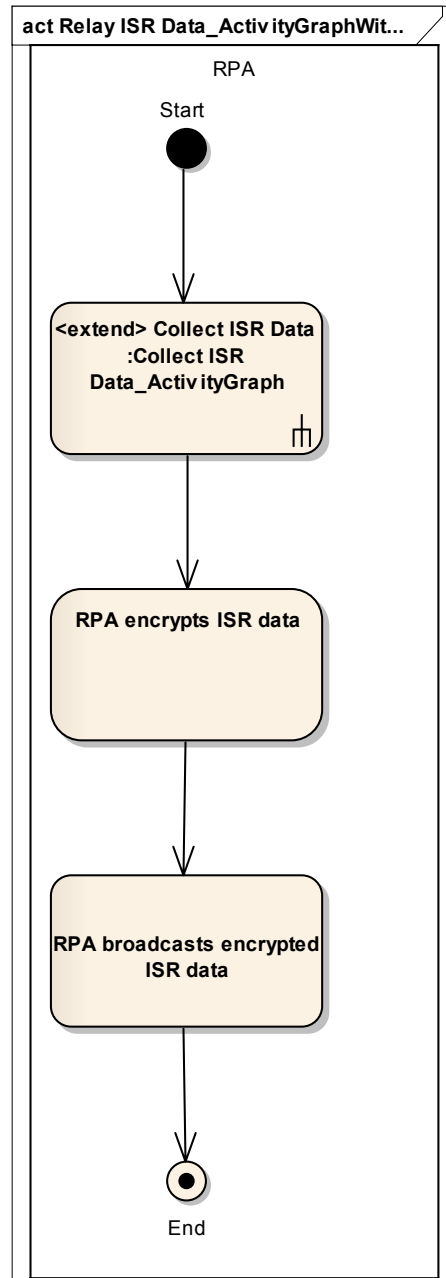

Diagram: Transfer Control

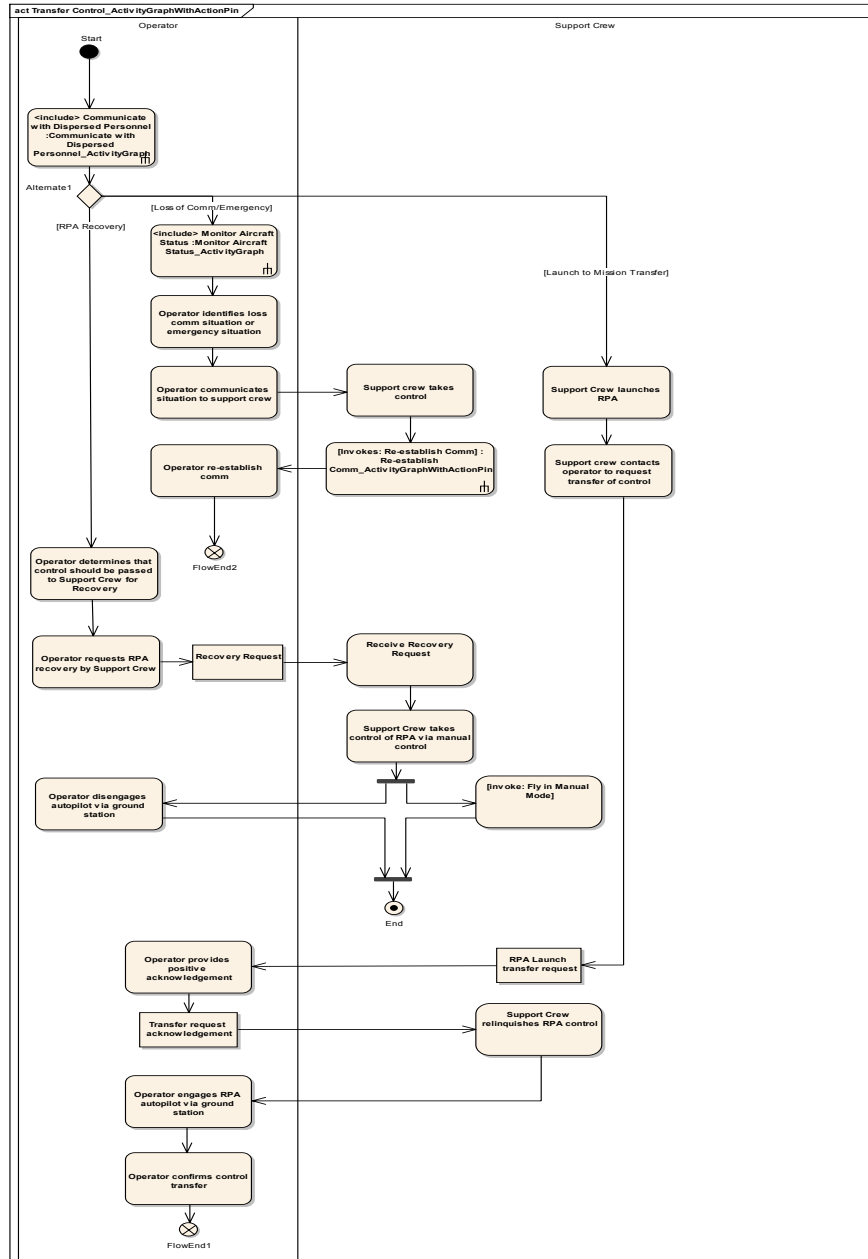
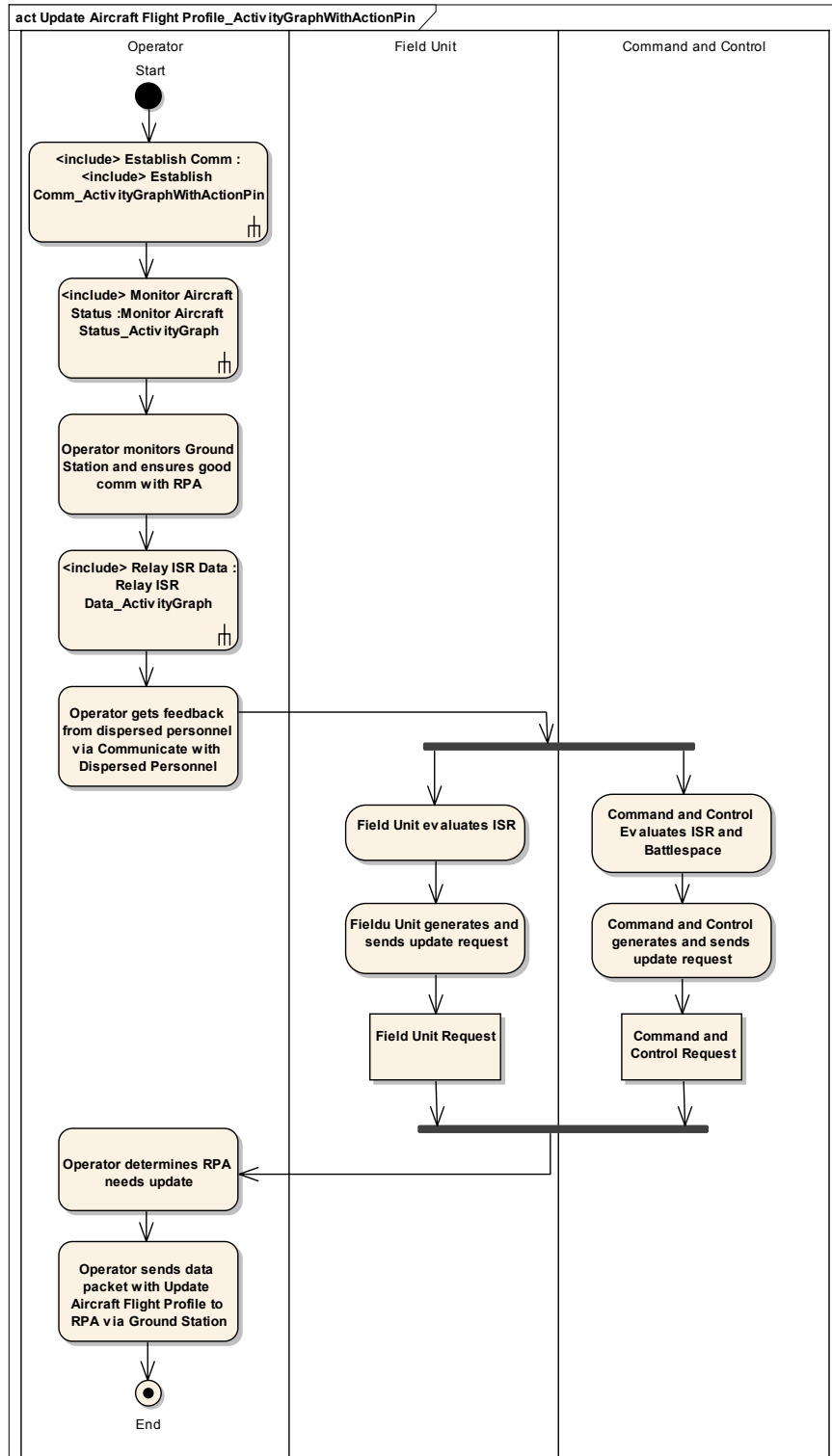

Diagram: Update Aircraft Flight Profile



Appendix D. Systems View 4 (SV-4) System Functionality Description

Function: Communicate

“As-intended”

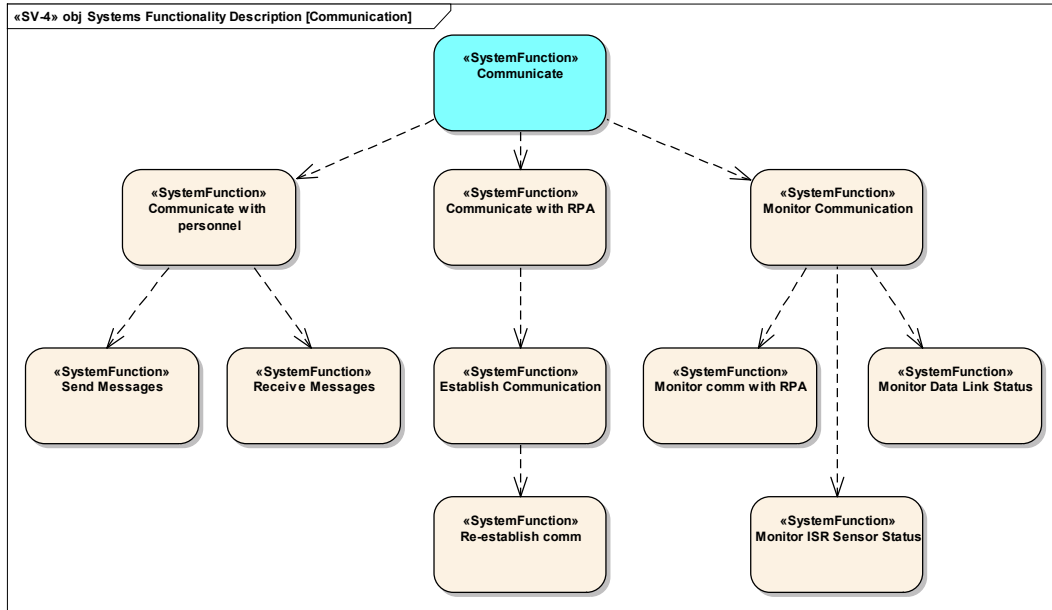

“As-built”

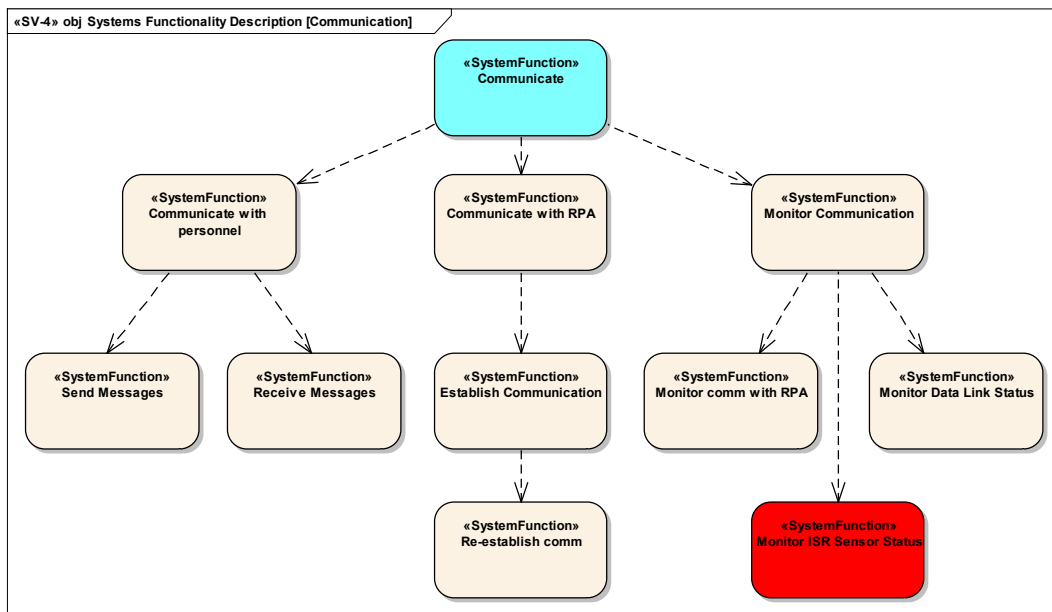

Function: Provide Electrical Power

“As-intended”

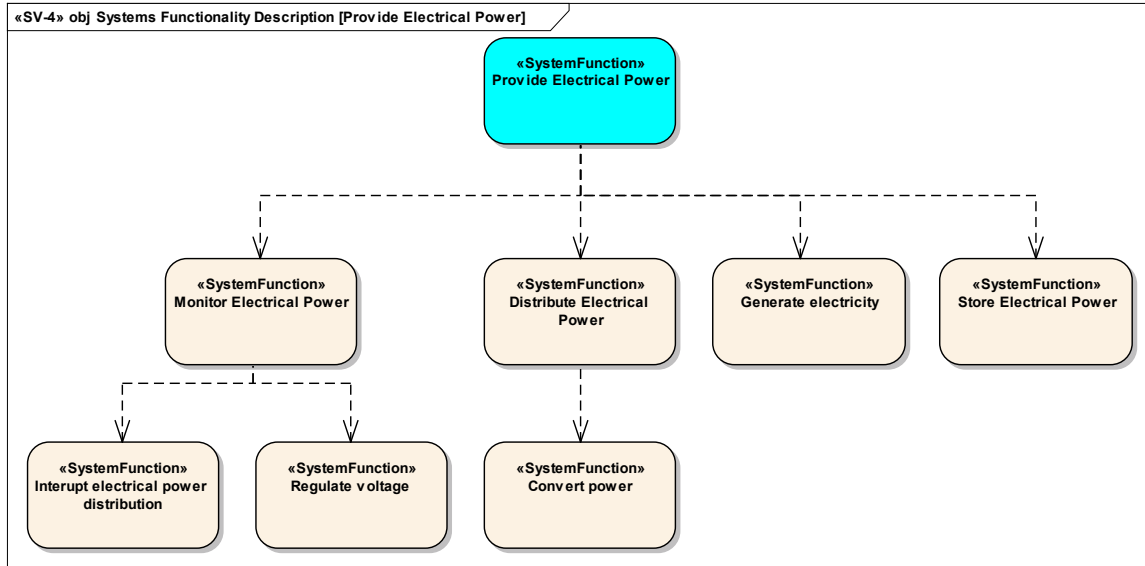

Function: Rapid Deployment and Recovery

“As-intended”

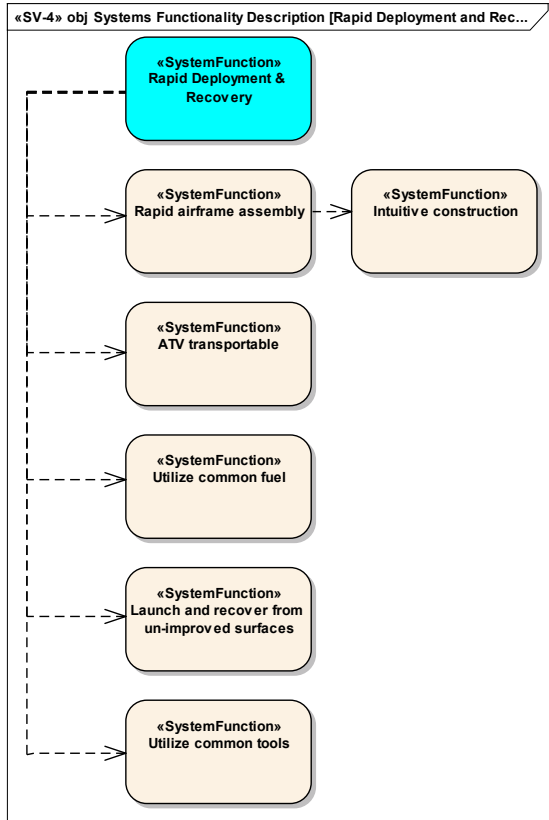

“As-Built”

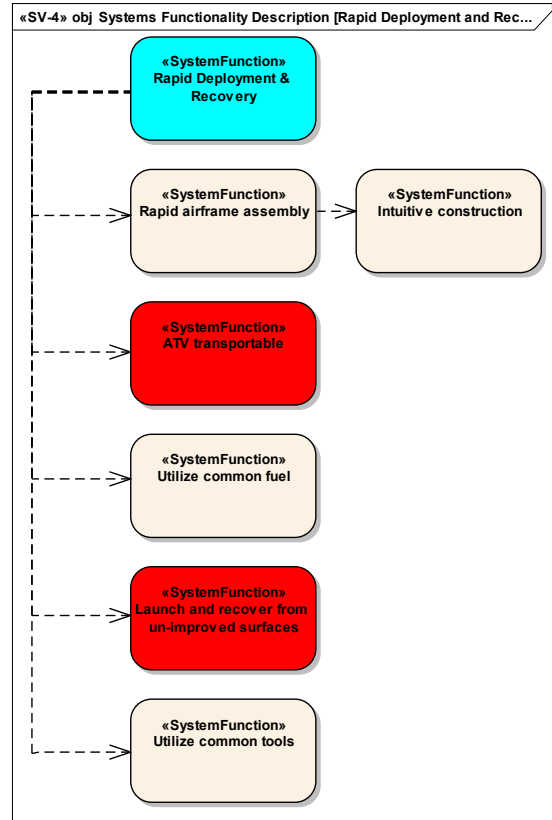

Function: Rapid Ingress & Egress

“As-Intended”

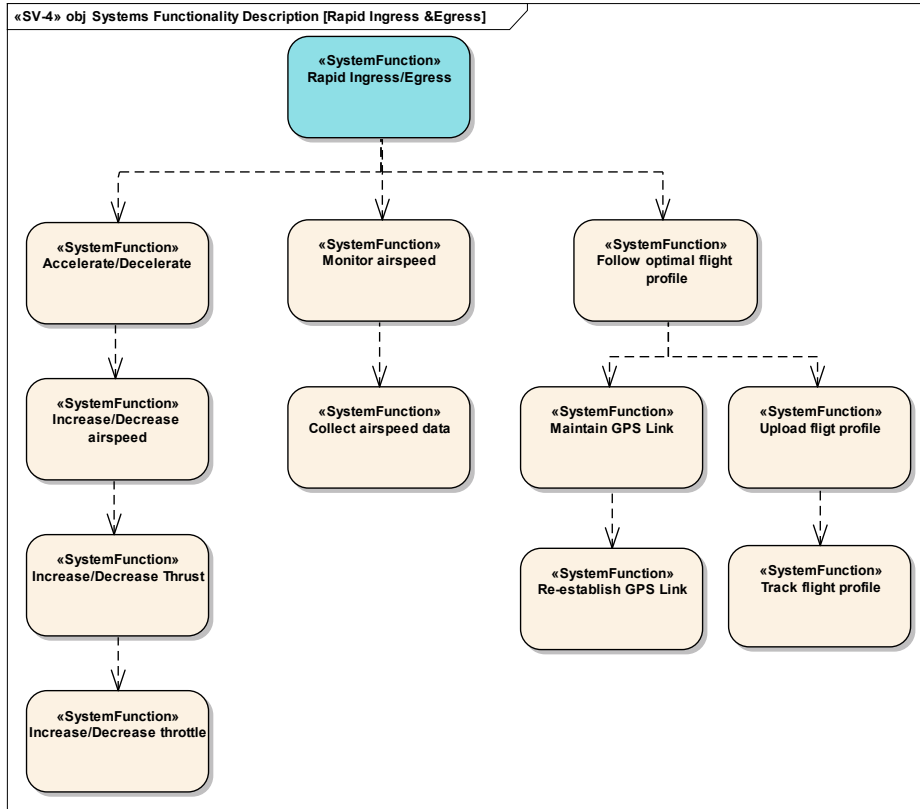

Function: RPA Control

“As-Intended”

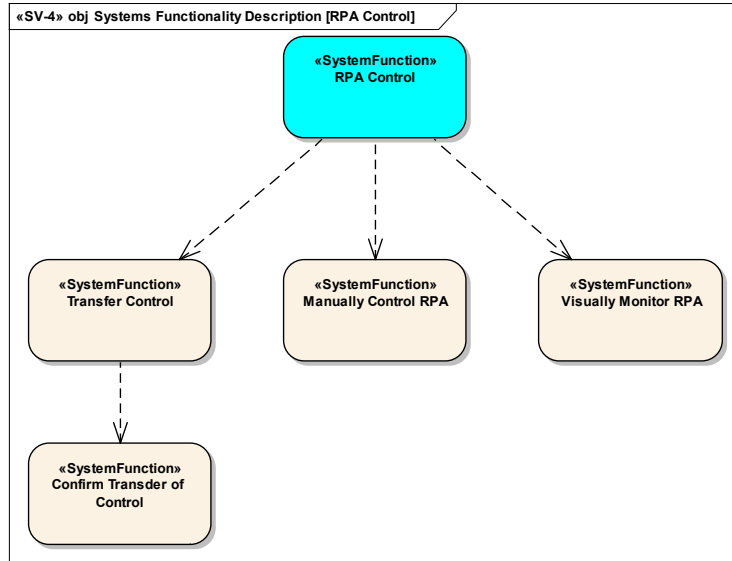

Appendix F. System Evolution Viewpoint (SV-8)

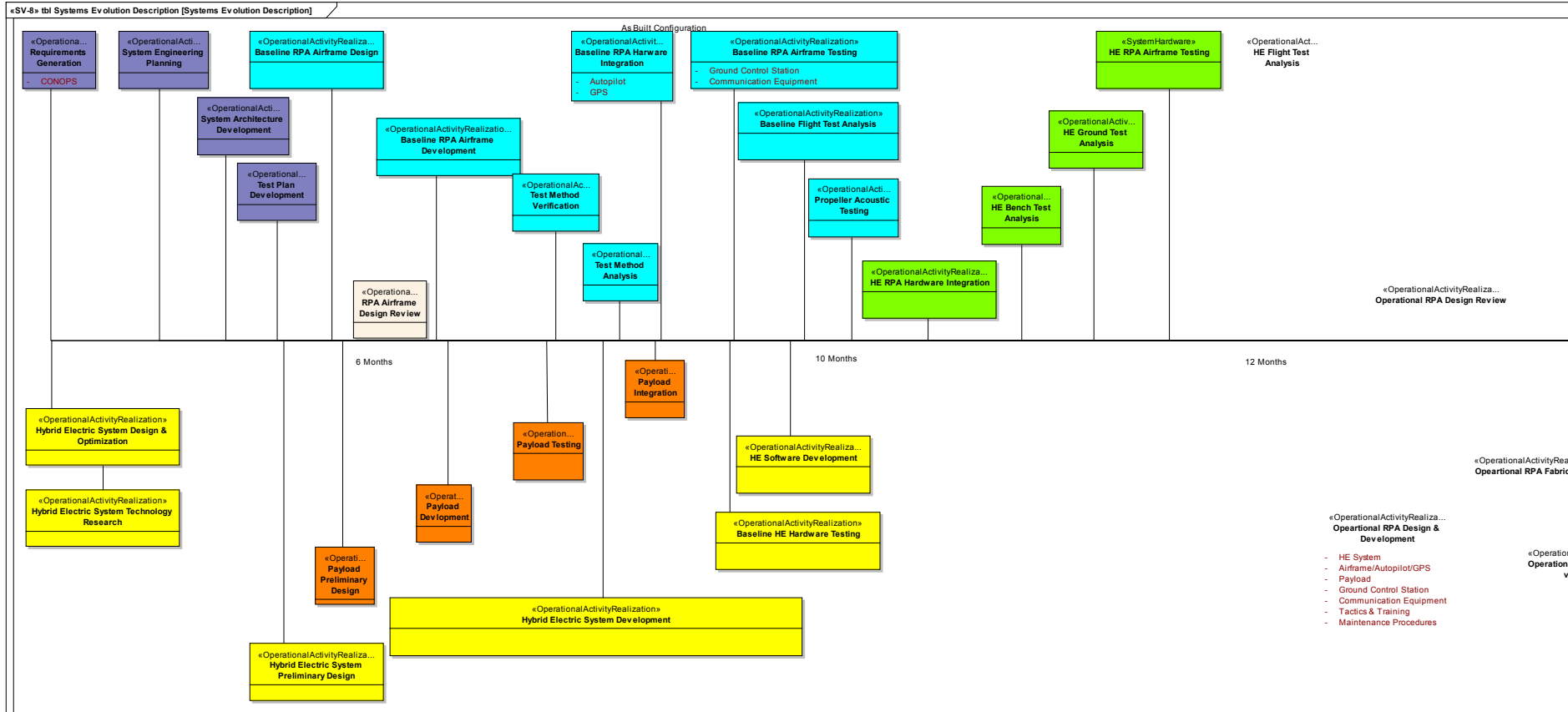

– continued on next

System Evolution Viewpoint (SV-8) - continued

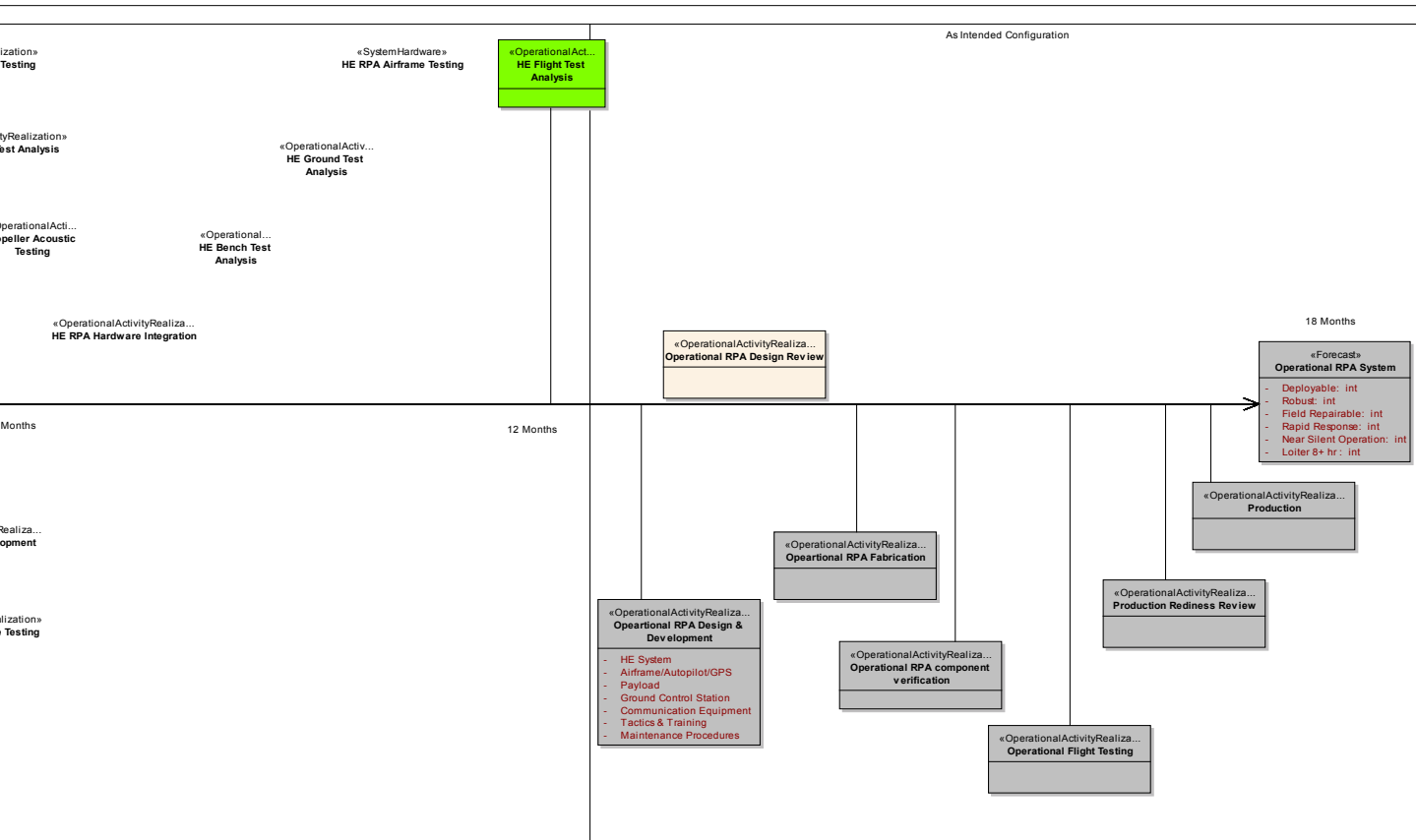

Appendix G. Technology Forecast (SV-9)

SV-9 Technology & Skills Forecast		Time Frame			
		6 Months	12 Months	18 Months	24+ Months
Technology	Batteries			Solid State Lithium Batteries [7]	Fuel Cell Based batteries [12]
	Electric Motors		Dual Drive Electric Motors [8]		High-Efficiency, High-Power-Density, Halbach Array Electric Motor [9]
	Controllers		Robust hybrid electric controller	Integrated autopilot & Hybrid controller	Man-equivalent reaction/process simulation [7]
	Materials	Resilient Kevlar & Carbon construction	Impact tolerant/Tough, non-resin based construction [4]	Vibration absorbent materials Reduced Composite & Optics material weight [7]	Shape Memory Alloys [7] Carbon fiber & steel truss structure [5]
	Construction Methods	Modular Payloads [3, 4]	Modular/interchangeable construction	Industry wide airworthiness standards [7]	RPAs designed as consumable items [7] NATO ISR Interoperability Standards [7]
		ISO 9002/ISO 9001 and IPC standards [6]			
		Robust & Rapid assembly [3]			
	Data Links	RPA/ground relay data links	Encrypted 2-9 GHz frequencies	Employment of Airborne Communication Nodes (ACN) [7]	Utilization of Wideband Network Waveform [7]
	Fuels	Flexible UAV bladders [11]	Small high efficiency fuel injection [13]		
	Payloads		Standardized HDTV formats [7]		
Propellers		Reduced dB performance	Tunable/morphing design	Propeller Optimization/Fluid Dynamics Code [xx]	
Prototyping	Large scale Rapid Prototyping of aerospace structures [10]				
	Rapid ABS Plastic utilization				
Skills	Personnel		Unique Air Force Specialty Code for RPA Operators [1]		
	Training	RPA Fabrication courses [15]	College training courses [16]	Dual operational & training systems [7]	Standardized interfaces [7]
			Training courses for RPA operators & Special Forces Teams [1]		
Fabrication	Utilization of Systems Engineering Approaches [14]	Requirements for standardized airframes and payloads [1]			

Predicted
Existing/Emerging

Appendix H. Throttle Redirect Code: Procerus Kestrel Autopilot

This appendix contains a sample of the code used in Virtual Cockpit to implement propulsion system control on the Kestrel autopilot. The sample code shown below was generated by the authors and integrated into an existing Procerus Virtual Cockpit GUI/add-in. The sample code shows the code used for capturing the throttle signal from the telemetry downlink stream. In addition, the code shows the packet intercept to divide the throttle between the ICE and EM based on flight mode. Autopilot signals to the ICE and EM are redirected and manipulated from the pre-installed gimbal camera functionality on the Kestrel autopilot. The sample code shown below is not all-inclusive; questions regarding the code should be directed towards the authors.

Throttle Capture Code

```
//Throttle
    unsigned char TempUChar;
    float rawThrottle;
    memcpy(&TempUChar, &NewPkt->PktData[39],1);
    rawThrottle = (TempUChar);
```

Mode And Throttle Splitting Code

```
//Throttle Command sent via Gimbal Command Packet

    sVCPacket GimbalPkt;
    CString EditStr;

    GimbalPkt.VCPacketType = VC_GIMBAL_CMD;
    GimbalPkt.DataSize = sizeof(sGimbalPacket);

    //Fill up the data
    sGimbalPacket GimbalCmd;
    GimbalCmd.DestAddr = m_UAVAddress;
    GimbalCmd.GimbalMode = 0; //GIMBAL MODE JOY MSL
```

```

////////////////////
//Mode Selection Code//
////////////////////

    int regen;

    //Determine Hybrid Mode Selection
    if(((CButton*)GetDlgItem(IDC_IDLE))->GetCheck())
    {
        GimbalCmd.GimbalAzm = 0.4f; //set idle to 20% throttle
        GimbalCmd.GimbalElev = 0.0f; //set servo position to off in radians
        regen = 0;
    }

    else if(((CButton*)GetDlgItem(IDC_ICE))->GetCheck())
    {
        GimbalCmd.GimbalAzm = rawThrottle/63.7f; //convert throttle signal in % to
radians for servo
        GimbalCmd.GimbalElev = 0.0f; //set servo position to off in radians;
        regen = 0;
    }

    else if(((CButton*)GetDlgItem(IDC_EM))->GetCheck())
    {
        GimbalCmd.GimbalAzm = 0.0f; //set servo position to off in radians
        GimbalCmd.GimbalElev = (rawThrottle * 0.9f) / 63.7f; //convert throttle signal (0-
100%) to 0-80% to limit PWM output to 4V instead of 5V
        regen = 0;
    }

//Boost Mode::ICE driver, Constant EM//
    else if(((CButton*)GetDlgItem(IDC_BOOST))->GetCheck())
    {
        GetDlgItem(IDC_IDEAL)->GetWindowText(EditStr);
        float IdealPower = (float)atof(EditStr);
        GimbalCmd.GimbalElev = (IdealPower * 0.90f) / 63.7f; //Constant EM-convert
throttle signal in % to radians for servo
        GimbalCmd.GimbalAzm = rawThrottle / 63.7f; //convert throttle signal in % to
radians for servo
        //GimbalCmd.GimbalElev = 0.785f; //set servo position to 50% in radian for EM
        regen = 0;
    }

```

```

//Boost Mode::EM driver, Constant ICE//
    else if(((CButton*)GetDlgItem(IDC_BOOST2))->GetCheck())
    {
        GetDlgItem(IDC_IDEAL)->GetWindowText(EditStr);
        float IdealPower = (float)atof(EditStr);
        GimbalCmd.GimbalAzm = IdealPower / 63.7f; //Constant ICE-convert throttle signal
in % to radians for servo
        //GimbalCmd.GimbalAzm = 0.628f; //set servo position to 40% in radian for ICE
        GimbalCmd.GimbalElev = (rawThrottle * 0.90f) / 63.7f; //convert throttle signal
(0-100%) to 0-80% to limit PWM output to 4V instead of 5V
        regen = 0;
    }

    else if(((CButton*)GetDlgItem(IDC_REGEN))->GetCheck())
    {
        GimbalCmd.GimbalAzm = (rawThrottle / 63.7f) * 1.1f; //Add 10% to throttle signal
        GimbalCmd.GimbalElev = 0.251f; //set servo position to 16% in radians
        regen = 1;
    }

        else // Ensure Idle Mode if default fails
        {
            GimbalCmd.GimbalAzm = 0.4f; //set idle to 20% throttle
            GimbalCmd.GimbalElev = 0.0f; //set servo position to off in radians
            regen = 0;
        }

        GimbalCmd.TrgtLat = 40.0f;
        GimbalCmd.TrgtLong = 40.0f;
        GimbalCmd.TrgtElev = 40.0f;

//Now that we have our structs filled copy the structs to the VC packet that will be
sent
        memcpy(GimbalPkt.PktData, &GimbalCmd, sizeof(sGimbalPacket));

//Finally send the packet
        m_VCConnector->SendData(&GimbalPk

```

Appendix I. Bench, Ground, and Flight Test Cards

This appendix contains all of the test cards for the bench, ground, and flight testing. The cards were developed by the authors and edited by Ausserer [12] to support the testing plan laid out in Appendix K. Completed test cards are annotated with the test data reproduced from Ausserer [12]. Notes and observations from during the test are also included.

1. BT-01: CONDOR HE ICE Only Bench Test Card

Completed: 31 January 2012, Attempt 1

Preconditions:

Aircraft secured in test stand, HE system passed functional check, and Autopilot installation and ground configuration procedures accomplished as described in Section 1 through Section 2.1 of the Procerus Installation and Configuration Guide Document Version 2.0, dated 10/27/08. Autopilot mode control add-in verified via HE functional check. Ensure adequate support and safety measures in place.

Note: Mission requires a Safety Observer (SO), HE System operator (HEO), and Virtual Cockpit operator (VCO). The entire test will be conducted in Manual Mode

CONDOR Configuration: No wings, N/A-lbs, 18x10 2-blade prop

Objective:

Verify performance of integrated HE system in ICE only mode under manual control

BT-01: PROCEDURES

Notes:

Duration: 30 min

ICE Throttle Response

1. **SO:** Ensure fire safety and test stand safety measures in place
2. **HEO:** Verify RC Mode (control boxes grayed out) and in "Manual Mode"
3. **HEO:** Record **starting fuel level**
4. **VCO:** Ensure VC and VC HE add-in loaded
5. **HEO:** Power-up and initiate HE system
6. **VCO:** Switch to RC Mode
7. **VCO:** Verify RC Mode (control boxes grayed out) and in "**Manual Mode**"
8. **VCO:** Set VC add-in **ICE Only Mode**
9. **VCO:** Set ICE throttle to 50% for start-up
10. **HEO:** Start HE system & Record **ICE start time**
11. **HEO:** Verify ICE system operating correctly

Starting Fuel Level: 1.825 kg

ICE Start Time: 12:13:03

% Throttle for Idle: 22%, 3050 rpm

Throttle Position (%): 30, 40, 50,

BT-01: PROCEDURES

12. **VCO:** Adjust throttle to **identify idle** position; restart if required
13. **VCO:** Increase throttle 10% hold 30 sec
14. **HCO:** Record engine speed
15. **HCO/VCO:** Repeat steps 13-14 until 100% throttle; stop if unacceptable vibration develops
16. **VCO:** Reduce throttle to 30% to simulate cruise, hold 20 min; Record starting Fuel Level & end fuel level for test point
17. **VCO:** Reduce throttle to 0%, Place **VC into SAFE mode**, Record ICE Stop time
18. **HCO:** Ensure HE system properly shut down
19. **VCO/HCO/SP:** Proceed to **Card BT-02**

Notes:

Duration: 30 min

60, 70, 80

Engine Speed (rpm): 3970, 4600, 5150,
5290, 5340, 5380**ICE Start Time:** 12:19:30**ICE Stop Time:** 12:39:30;**Engine Speed:** 4020 rpm**Fuel Level:** **Start:** 1.780 kg,
End: 1.730 kg

Notes/Observations: Test accomplished successfully on first attempt. Aircraft is capable of ICE only operation. Solo Whistle maintained commutation and alignment during entire test, although this was not a test objective.

2. BT-02: CONDOR HE EM Only Bench Test Card

Completed: 1 February 2012, Attempt 1

Preconditions:

Aircraft secured in test stand, HE system passed functional check, and Autopilot installation and ground configuration procedures accomplished as described in Section 1 through Section 2.1 of the Procerus Installation and Configuration Guide Document Version 2.0, dated 10/27/08. Autopilot mode control add-in verified via HE functional check. Ensure adequate support and safety measures in place.

Note: Mission requires a Safety Observer (SO), HE System operator (HEO), and Virtual Cockpit operator (VCO). The entire test will be conducted in Manual Mode

CONDOR Configuration: No wings, N/A-lbs, 18x10 2-blade prop

Objective:

Verify performance of integrated HE system in EM only mode under manual control

BT-02: PROCEDURES

Notes:

Dur: 30 min

EM Throttle Response

1. **SO:** Ensure fire safety and test stand safety measures in place
2. **HEO:** Verify RC Mode (control boxes grayed out) and in "Manual Mode"
3. **VCO:** Ensure VC and VC HE add-in loaded
4. **HEO:** Power-up and initiate HE system; Start EM (commutate)
5. **VCO:** Switch to **Manual Mode**
6. **VCO:** Verify RC Mode (control boxes grayed out) and in "**Manual Mode**"
7. **VCO:** Set VC add-in **EM Only Mode**
8. **VCO:** Set EM throttle to 0% for start-up
9. **HEO:** Verify HE system operating correctly (ICE will be at 0%)
10. **VCO:** Adjust throttle to identify min **EM run position** (EM idle)

% Throttle for min EM run position: 15%

Throttle Position (%): 21, 30, 40,

BT-02: PROCEDURES

Notes:

Dur: 30 min

11. **VCO:** Increase throttle 10% hold 30 sec
12. **HEO:** Record battery **pack voltage & current draw & cumulative power & motor speed**
13. **HEO/VCO:** Repeat steps 13-14 until 100% throttle
14. **VCO:** Reduce throttle to 0%, Place **VC into SAFE mode**
15. **HEO:** Ensure HE system properly shut down
16. **VCO/HEO/SP:** Proceed to **Card BT-03**

50, 60, 70, 80, 90,

96

Pack Voltage (V): 32.9, 32.9, 32.9,
32.8, 32.8 32.5, 32.5, 32.5,
32.3

Current Draw (A): -0.6, 0.0, 0.74,
1.8, 2.9, 4.1, 5.3, 7.0,
8.0

Cumulative Power (mAh): **Initial:** 14

16, 19, 23,
33, 51, 78, 111, 157,
202

Motor Speed (rpm): 1550, 1630, 2120,
2490 2860, 3160, 3420, 3710,
390

Notes/Observations: Test accomplished successfully on first attempt. Aircraft is capable of EM only operation. Operational speeds (rpm) were lower than expected based on simulation, as were current draws from the batteries. This is more likely due to the performance limits of the Solo Whistle controller than the motor or batteries. The system should still be capable of endurance flight based on power draw from the batteries. Pack current was not zeroed at the beginning of the test. There is a -0.7 A offset in the data.

3. BT-03: CONDOR HE ICE to EM Bench Test Card

Completed: 1 February 2012, Attempt 2

Preconditions:

Aircraft secured in test stand, HE system passed functional check, and Autopilot installation and ground configuration procedures accomplished as described in Section 1 through Section 2.1 of the Procerus Installation and Configuration Guide Document Version 2.0, dated 10/27/08. Autopilot mode control add-in verified via HE functional check. Ensure adequate support and safety measures in place.

Note: Mission requires a Safety Observer (SO), HE System operator (HEO), and Virtual Cockpit operator (VCO). The entire test will be conducted in Manual Mode

CONDOR Configuration: No wings, N/A–lbs, 18x10 2-blade prop

Objective:

Verify HE can transition from ICE mode to EM mode in manual control and then operate in EM mode

BT-03: PROCEDURES

Notes:

Dur: 30 min

HE Mode Response

1. **SO:** Ensure fire safety and test stand safety measures in place
2. **HEO:** Verify VC in “Safe Mode”
3. **VCO:** Ensure VC and VC HE add-in loaded
4. **HEO:** Power-up and initiate HE system; commutate EM
5. **VCO:** Switch to **Manual Mode**
6. **VCO:** Verify RC Mode (control boxes grayed out) and in “**Manual Mode**”
7. **VCO:** Set VC add-in **ICE Only Mode**
8. **VCO:** Set ICE throttle to 50% for start-up
9. **HEO:** Start HE system
10. **HEO:** Verify HE system operating correctly
11. **VCO:** Adjust throttle to 10-20% above ICE idle
12. **VCO:** Set VC add-in **EM Only Mode**

EM Response Verification:

(throttle settings, propeller speed, and pack current draw)

ICE: Idle;	EM: 42%; 3.6 A	4350 rpm
ICE: Idle;	EM: 35%; 2.8 A	4160 rpm
ICE: Idle;	EM: 54%; 5.0 A	4700 rpm

BT-03: PROCEDURES

Notes:

Dur: 30 min

13. **HEO:** Verify EM running at correct throttle setting
14. **HEO:** Verify ICE reduced to idle
15. **VCO/HEO/SP:** Proceed to **Card BT-04**

HE System Operating Correctly: Yes**EM at throttle:** Yes**ICE at Idle:** Yes**Notes/Observations:** EM is not overrunning ICE, even with ICE at idle throttle.**Attempt 1:** During the first attempt, the ICE turned off instead of going to idle throttle. The coding for idle throttle in Virtual Cockpit had been set to 0% instead of 22% as determined during BT01. After correction, attempt 2 was successful.

4. BT-04: CONDOR HE EM to ICE Bench Test Card

Completed: 1 February 2012, Attempt 1

Preconditions:

Aircraft secured in test stand, HE system passed functional check, and Autopilot installation and ground configuration procedures accomplished as described in Section 1 through Section 2.1 of the Procerus Installation and Configuration Guide Document Version 2.0, dated 10/27/08. Autopilot mode control add-in verified via HE functional check. Ensure adequate support and safety measures in place.

Note: Mission requires a Safety Observer (SO), HE System operator (HEO), and Virtual Cockpit operator (VCO). The entire test will be conducted in Manual Mode

CONDOR Configuration: No wings, N/A-lbs, 18x10 2-blade prop

Objective:

Verify HE can transition from EM mode to ICE mode in manual control

BT-04: PROCEDURES

Notes:

Dur: 30 min

HE Mode Response

1. **SO:** Ensure fire safety and test stand safety measures in place
2. **HEO:** Verify VC in "Safe Mode"
3. **VCO:** Ensure VC and VC HE add-in loaded
4. **HEO:** Power-up and initiate HE system; Commutate EM
5. **VCO:** Switch to **Manual Mode**
6. **VCO:** Verify RC Mode (control boxes grayed out) and in "**Manual Mode**"
7. **VCO:** Set ICE throttle to 50% for start-up
8. **HEO:** Start HE system
9. **HEO:** Verify HE system operating correctly
10. **VCO:** Set VC add-in **EM Only Mode**, adjust throttle (EM) to 30% to ensure control
11. **HEO:** Verify ICE goes to idle
12. **VCO:** Switch to ICE only

Throttle controlling EM: Yes

ICE to Idle: Yes

BT-04: PROCEDURES

Notes:

Dur: 30 min

13. **HCO:** Verify EM off
14. **HCO:** Verify ICE at set throttle
15. **VCO/HCO/SP:** Proceed to **Card BT-05, BT-06**

EM turns off: Yes**Throttle controlling ICE:** Yes

Notes/Observations: Throttle verification performed by watching for a change in propeller speed (rpm) as throttle was adjusted by a 10% step.

5. BT-05, BT-06: CONDOR HE Dual Mode Bench Test Card

Completed: 1 February 2012, Attempt 1

Preconditions:

Aircraft secured in test stand, HE system passed functional check, and Autopilot installation and ground configuration procedures accomplished as described in Section 1 through Section 2.1 of the Procerus Installation and Configuration Guide Document Version 2.0, dated 10/27/08. Autopilot mode control add-in verified via HE functional check. Ensure adequate support and safety measures in place.

Note: Mission requires a Safety Observer (SO), HE System operator (HEO), and Virtual Cockpit operator (VCO). The entire test will be conducted in Manual Mode

CONDOR Configuration: No wings, N/A-lbs, 18x10 2-blade prop

Objective:

Verify HE can transition to dual mode (EM driver and ICE driver) in manual control

BT-05, BT-06: PROCEDURES

Notes:

Dur: 30 min

EM Driver Test: BT-05

1. **VCO:** Set Dual Mode (ICE) value at 10-30%
2. **VCO:** Set VC add-in to **Dual Mode (EM Boost)**
3. **VCO:** Decrease throttle (EM) to 0%
4. **HEO:** Verify EM powers down & ICE remains at 10-30% setting
5. **VCO:** Increase throttle (EM) to 30% hold 30 sec
6. **HEO:** Verify EM powers up
7. **VCO:** Increase throttle (EM) to 40%
8. **HEO:** Verify EM powers up
9. **VCO:** Change ICE set point to 40%
10. **HEO:** Verify ICE powers up

EM Driver Response Verification:

(throttle settings, propeller speed, and pack current draw)

Initial:

ICE: 30%; EM: 31%; 4460 rpm
3.6 A

Adjust Dual Mode throttle:

ICE: 30%; EM: 43%; 4670 rpm
4.0 A

Adjust ICE Set point:

ICE: 40%; EM: 43%; 5360 rpm
4.2 A

ICE Driver: BT-06

BT-05, BT-06: PROCEDURES

Notes:

Dur: 30 min

11. **VCO:** Set throttle (EM) at 50%, ICE set point at 30%
12. **VCO:** Switch to ICE driver
13. **HEO:** Verify EM switches to 30% setting & ICE powers up to 50%
14. **VCO:** Decrease throttle (ICE) to 20%
15. **HEO:** Verify ICE powers down
16. **VCO:** Increase throttle (ICE) to 30%
17. **HEO:** Verify ICE powers up
18. **VCO:** Change EM set point to 40%
19. **HEO:** Verify EM powers up
20. **HEO:** Return to ICE only mode
21. **VCO/HEO/SP:** Proceed to **Card BT-07**

ICE Driver Response Verification:

(throttle settings, propeller speed, and pack current draw)

Initial:

ICE: 19%; EM: 30%; 3507 rpm
1.9 A

Adjust Dual Mode throttle:

ICE: 30%; EM: 30%; 4500 rpm
2.4 A

Adjust EM Set point:

ICE: 40%; EM: 50%; 4800 rpm
5.2 A

Notes/Observations: The EM was never able to overrun the ICE. ICE speed increased with EM throttle at all times. Also, above 50% EM throttle, the behavior of the ICE servo became erratic. Moving the ICE servo wire mitigated the behavior, but shielding should be included for the signal in the final aircraft, as the wire runs alongside the EM power and magneto.

6. BT-07: CONDOR HE Emergency Kill Bench Test Card

Completed: 1 February 2012, Attempt 1

Preconditions:

Aircraft secured in test stand, HE system passed functional check, and Autopilot installation and ground configuration procedures accomplished as described in Section 1 through Section 2.1 of the Procerus Installation and Configuration Guide Document Version 2.0, dated 10/27/08. Autopilot mode control add-in verified via HE functional check. Ensure adequate support and safety measures in place.

Note: Mission requires a Safety Observer (SO), HE System operator (HEO), and Virtual Cockpit operator (VCO). The entire test will be conducted in Manual Mode

CONDOR Configuration: No wings, N/A-lbs, 18x10 2-blade prop

Objective:

Verify HE ICE can be killed in emergency situation and that the EM still functions

BT-07: PROCEDURES

Notes:

Dur: 30 min

HE System Kill Verification

1. **HEO:** Ensure system started & EM commutated
2. **VCO:** Verify system is in ICE mode
3. **VCO:** Ensure throttle (ICE) set to 30%
4. **HEO:** Activate ICE kill switch
5. **HEO:** Verify ICE stops (EM already off)
6. **VCO/HEO: Restart HE system in ICE only**
7. **VCO:** Set Dual Mode (EM Driver) to ICE constant value 40%
8. **VCO:** Set VC add-in to **Dual Mode (EM Driver)**
9. **HEO:** Verify EM operating at 30% & ICE operating at 40%
10. **HEO:** Activate ICE kill switch
11. **HEO:** Verify ICE stops
12. **VCO:** Increase throttle (EM) to 60%

Notes/Observations: Despite concerns about EM commutation loss during an ICE shutdown, EM functioned flawlessly with no loss of commutation.

BT-07: PROCEDURES

Notes:

Dur: 30 min

13. **HCO:** Verify EM powers up & functions after ICE kill
14. **VCO:** Set throttle to 0%
15. **VCO:** Place VC in **Safe Mode**
16. **HCO:** Power down HE system
17. **VCO/HCO/SP:** Proceed to **Card BT-08**

7. BT-08: CONDOR HE Emergency Kill Bench Test Card

Completed: 1 February 2012, Attempt 1

Preconditions:

Aircraft secured in test stand, HE system passed functional check, and Autopilot installation and ground configuration procedures accomplished as described in Section 1 through Section 2.1 of the Procerus Installation and Configuration Guide Document Version 2.0, dated 10/27/08. Autopilot mode control add-in verified via HE functional check. Ensure adequate support and safety measures in place.

Note: Mission requires a Safety Observer (SO), HE System operator (HEO), and Virtual Cockpit operator (VCO). The entire test will be conducted in Manual Mode

CONDOR Configuration: No wings, N/A-lbs, 18x10 2-blade prop

Objective:

Verify HE EM can be killed in emergency situation

BT-08: PROCEDURES

Notes:

Dur: 30 min

HE System EM Kill Verification

1. **SO:** Ensure fire safety and test stand safety measures in place
2. **HEO:** Verify RC Mode (control boxes grayed out) and in "Manual Mode"
3. **VCO:** Ensure VC and VC HE add-in loaded
4. **HEO:** Power-up and initiate HE system
5. **VCO:** Switch to RC Mode
6. **VCO:** Verify RC Mode (control boxes grayed out) and in "Manual Mode"
7. **VCO:** Set VC add-in ICE Only Mode
8. **VCO:** Set ICE throttle to 50% for start-up
9. **HEO:** Start HE system
10. **HEO:** Verify HE system operating correctly
11. **VCO:** Adjust throttle to ICE idle position

Response Verification:

(throttle settings, propeller speed)

ICE: 30%; EM: 30%; 4500 rpm

ICE: 30%; EM: Off; 4000 rpm

Notes/Observations: No issues with EM shutdown.

BT-08: PROCEDURES

Notes:

Dur: 30 min

12. **VCO:** Set Dual Mode (EM Driver) with ICE constant value at 30 %
13. **VCO:** Set VC add-in to **Dual Mode (EM Boost)**
14. **HEO:** Verify EM throttle control & ICE operating at 30%
15. **HEO:** Set throttle (EM) at 30%
16. **HEO:** Activate EM kill switch
17. **HEO:** Verify EM stops
18. **HEO:** Verify ICE remains at 30%
19. **VCO/HEO/SP:** Proceed to **Card BT-09**

8. BT-09: CONDOR HE ICE Crossover Bench Test Card

Completed: 3 February 2012, Attempt 3

Preconditions:

Aircraft secured in test stand, HE system passed functional check, and Autopilot installation and ground configuration procedures accomplished as described in Section 1 through Section 2.1 of the Procerus Installation and Configuration Guide Document Version 2.0, dated 10/27/08. Autopilot mode control add-in verified via HE functional check. Ensure adequate support and safety measures in place.

Note: Mission requires a Safety Observer (SO), HE System operator (HEO), and Virtual Cockpit operator (VCO). The entire test will be conducted in Manual Mode

CONDOR Configuration: No wings, N/A-lbs, 18x10 2-blade prop

Objective:

Verify HE ICE Crossover functions correctly

BT-09: PROCEDURES	Notes: Dur: 30 min
<p><u>HE System ICE Crossover Verification</u></p> <ol style="list-style-type: none">1. VCO: Set VC add-in to ICE Mode2. VCO: Increase throttle (ICE) to 40%3. HEO: Activate ICE Crossover switch4. VCO: Switch from ICE mode to EM mode5. VCO: Vary manual throttle 10-30% (Ice should respond to manual control in EM mode)6. HEO: Verify ICE positive response7. VCO: Verify HE (ICE control) mode control inactive & control through Kestrel AP8. HEO: Deactivate Crossover switch, verify ICE control9. VCO: Switch from ICE mode to EM mode	<p>Notes/Observations: No issues with EM shutdown.</p> <p>Attempt 1&2: When the crossover was activated, the engine speed increased rapidly and the belt came off of the EM pulley. There exists an offset between the manual and autopilot servo ranges, causing the rapid throttle variation. This servo range was correct before attempt 3.</p>

BT-09: PROCEDURES

Notes:

Dur: 30 min

10. **VCO:** Vary throttle 10-30%
11. **HCO:** Verify EM positive response
12. **VCO:** Verify HE mode control active & control through Kestrel AP inactive
13. **VCO/HCO/SP:** Proceed to **Card BT-10**

9. BT-10: CONDOR HE Regen Test Card

Completed: 1 February 2012, Attempt 1

Preconditions:

Aircraft secured in test stand, HE system passed functional check, and Autopilot installation and ground configuration procedures accomplished as described in Section 1 through Section 2.1 of the Procerus Installation and Configuration Guide Document Version 2.0, dated 10/27/08. Autopilot mode control add-in verified via HE functional check. Ensure adequate support and safety measures in place.

Note: Mission requires a Safety Observer (SO), HE System operator (HEO), and Virtual Cockpit operator (VCO). The entire test will be conducted in Manual Mode

CONDOR Configuration: No wings, N/A-lbs, 18x10 2-blade prop

Objective:

Verify HE EM ReGen functions correctly

BT-10: PROCEDURES

Notes:

Dur: 30 min

HE System ReGen Verification

1. **HEO:** Record battery **starting battery voltage**, ensure at least 2V under max
2. **HEO:** Verify EM initially off
3. **VCO:** Set VC add-in to **Regen Mode**, Record **start time**
4. **VCO:** Increase throttle (ICE) to 30%
5. **HEO:** Monitor battery pack voltage, record time for voltage to increase 0.5V (do not start with fully charged battery packs)
6. **VCO:** Set VC add-in to **ICE Mode**
7. **VCO:** Decrease throttle to 20%
8. **HEO:** Verify ICE throttle response
9. **VCO:** Set VC add-in to **EM Mode**

Starting Battery Voltage: 31.5 V

Start Time: 12:06:10

End Time: 12:28:06

End Battery Voltage: 32.0 V

Total power (mAh): 300

Regen Verification:

(throttle settings, propeller speed, pack current)

BT-10: PROCEDURES

10. **HEO:** Verify ICE goes to Idle
11. **VCO:** Increase throttle to 40%
12. **HEO:** Verify EM responds to throttle
13. **VCO:** Decrease throttle to 0%
14. **HEO:** Power down HE system
15. **VCO:** Power Down VC/Kestrel AP
16. **VCO/HEO/SP:** End Test

Notes:

Dur: 30 minICE: 30%; EM: Off; 4130 rpm
0 AICE: 30%; EM: Regen; 4050 rpm
1.15 A**Notes/Observations:** Only two battery packs were used during the Regeneration test for safety reasons.

10. GT-00: CONDOR HE Kill Mode Verification Test Card

Completed, Qualitatively, No Telemetry Data (interference issues), 15 February 2012

Preconditions:

Ground Control Station (GCS) set up and proper GCS operation verified. Ensure adequate support and safety measures in place.

Note: Mission requires a Safety Observer (SO), HE System operator (HEO), and Virtual Cockpit operator (VCO).

CONDOR Configuration: 12-ft, 35 lbs, 18x10 2-blade prop

Objective:

Verify HE system kill modes

GT-00: PROCEDURES

Notes:

Dur: 30 min

Kill mode verification

20. **SO:** Ensure fire safety and test safety measures in place
21. **VCO:** Ensure VC in **Safe Mode** prior to HE-RPA startup
22. **VCO:** Perform Pre-engine start-up portion of *Launch Checklist*
23. **VCO:** Verify RC Mode (control boxes grayed out) and in “**Manual Mode**”
24. **SO:** Ensure RPA is restrained & personnel have PPE

25. **HEO:** Conduct HE-RPA startup checklist
26. **VCO:** Set VC HE add-in to **ICE only** mode
27. **HEO:** Activate ICE kill switch
28. **HEO/VCO/SO:** Repeat steps 3-6
29. **VCO:** Set VC HE add-in to **EM only** mode (Ice idle)
30. **HEO:** Activate EM kill switch
31. **VCO:** Place VC in **Safe Mode**
32. **SP/HEO/VCO:** Proceed to GT-01

ICE killed: Yes / No

EM killed: Yes / No

11. GT-01: CONDOR HE Takeoff and Dual Mode Ground Test Card

Completed, Qualitatively, No Telemetry Data (interference issues), 15 February 2012

Preconditions:

Ground Control Station (GCS) set up and proper GCS operation verified. Ensure adequate support and safety measures in place.

Note: Mission requires a Safety Observer (SO), HE System operator (HEO), and Virtual Cockpit operator (VCO). The entire test will be conducted in Manual Mode

CONDOR Configuration: No Wings, 35 lbs, 18x10 2 blade prop

Objective:

Verify takeoff (simulated) & performance of integrated HE system in dual (ICE Boost) mode

GT-01: PROCEDURES

Notes:

Dur: 30 min

Takeoff & Dual Mode (ICE boost)

1. **SO:** Ensure fire safety and test safety measures in place
2. **VCO:** Ensure CONDOR PID Values uploaded , & waypoints (WPAFB) loaded into VC
3. **VCO:** Ensure VC in **Safe Mode** prior to HE-RPA startup
4. **HEO:** Record starting fuel level of RPA
5. **HEO:** Record starting battery voltage and current draw
6. **VCO:** Perform Pre-engine start-up portion of *Launch Checklist*
7. **VCO:** Verify RC Mode (control boxes grayed out) and in “**Manual Mode**”
8. **VCO:** Place VC HE add-in to **ICE Only**

Starting Fuel Level: _____

Starting battery voltage: _____

Starting Current Draw: _____

GT-01: PROCEDURES

Notes:

Dur: 30 min

9. **HCO:** Conduct HE-RPA startup checklist, record **ICE start time**
10. **SP:** Adjust **ICE throttle** to **idle**
11. **VCO:** Set VC HE add-in to **Dual Mode (ICE Boost)**, set EM constant to 30%
12. **VCO:** Adjust EM constant to lower value if needed to prevent taxi
13. **SP:** Increase ICE throttle until RPA begins to taxi
14. **SP:** Accelerate RPA to simulate takeoff
15. **SP:** Record throttle position for estimated takeoff speed (if not 100%)
16. **VCO:** Record **throttle** position, **estimated speed**, and **engine speed**
17. **SP:** Reduce throttle, rotate RPA 180deg and repeat in opposite direction
18. **SP:** Determine if EM throttle constant needs to be adjusted up or down
19. **VCO:** Adjust EM throttle constant as necessary for proceeding trial
20. **SP/VCO/HCO:** Repeat steps 10-15 until SP identifies preferred throttle combination
21. **VCO:** Place RPA in **IDLE Mode**
22. **VCO/HCO/SP:** Proceed to **Card GT-02**

ICE Start Time: _____**Min EM Throttle Constant:** ____**% Throttle:** __, __, __, __, __**Estimated Takeoff speed:** __, __, __, __, __**Propeller Speed:** __, __, __, __, __**Current Draw:** __, __, __, __, __**EM Throttle Constant:** __, __, __, __, __

12. GT-02: CONDOR HE ICE Mode Test Card

Completed, Qualitatively, No Telemetry Data (interference issues), 15 February 2012

Preconditions:

Completion of Test Card GT-01, Ground Control Station (GCS) set up and proper GCS operation verified. Ensure adequate support and safety measures in place.

Note: Mission requires a Safety Observer (SO), HE System operator (HEO), and Virtual Cockpit operator (VCO). The entire test will be conducted in Manual Mode

CONDOR Configuration: 12-ft, 35 lbs, 18x10 2-blade prop

Objective:

Verify correct operation of HE RPA ICE mode & mode switching

GT-02: PROCEDURES

Notes:

Dur: 30 min

ICE Only Mode Checkout

1. **VCO:** Set VC HE add-in to **ICE only** mode
2. **SP/HEO:** Verify EM off & ICE responds to manual throttle commands
3. **SP:** Increase throttle until RPA begins to taxi
4. **VCO:** Record min taxi throttle setting, min taxi speed, and engine speed
5. **SP:** Taxi RPA for 4 laps, operator choice of throttle
6. **VCO:** Place RPA in **Idle**
7. **VCO/HEO/SP:** Proceed to **Card GT-03**

% Throttle for taxi: _____

Min taxi speed: _____

Min Engine Speed: _____

Taxi throttle: _____

Taxi Prop Speed: _____

13. GT-03: CONDOR HE EM Mode Test Card

Completed, Qualitatively, No Telemetry Data (interference issues), 15 February 2012

Preconditions:

Completion of Test Card GT-02, Ground Control Station (GCS) set up and proper GCS operation verified. Ensure adequate support and safety measures in place.

Note: Mission requires a Safety Observer (SO), HE System operator (HEO), and Virtual Cockpit operator (VCO). The entire test will be conducted in Manual Mode

CONDOR Configuration: 12-ft, 35 lbs, 18x10 2-blade prop

Objective:

Verify correct operation of HE-RPA EM mode & mode switching

GT-03: PROCEDURES

Notes:

Dur: 30 min

EM Only Mode Checkout

1. **VCO:** Set VC HE add-in to **EM only** mode
2. **SP/HEO:** Verify EM responds to manual throttle commands & ICE goes to idle
3. **SP:** Increase throttle until RPA begins to taxi
4. **VCO:** Record min taxi throttle setting, min taxi speed, and engine speed
5. **SP:** Taxi RPA for 4 laps, operator choice of throttle
6. **VCO:** Place RPA in **Idle**
7. **VCO/HEO/SP:** Proceed to **Card GT-04**

% Throttle for taxi: _____

Min taxi speed: _____

Min Engine Speed: _____

Min current draw: _____

Taxi throttle: _____

Taxi Prop Speed: _____

Current draw: _____

GT-04: CONDOR HE ICE Mode Test Card

Completed, Qualitatively, No Telemetry Data (interference issues), 15 February 2012

Preconditions:

Completion of Test Card GT-01, Ground Control Station (GCS) set up and proper GCS operation verified. Ensure adequate support and safety measures in place.

Note: Mission requires a Safety Observer (SO), HE System operator (HEO), and Virtual Cockpit operator (VCO). The entire test will be conducted in Manual Mode

CONDOR Configuration: 12-ft, 35 lbs, 18x10 2-blade prop

Objective:

Verify correct operation of HE-RPA Dual mode & mode switching

GT-04: PROCEDURES

Notes:

Dur: 30 min

Dual Mode (EM Boost) Checkout

1. **VCO:** Set VC HE add-in throttle constant to 40% (ICE will be 40%)** Reduce if needed
2. **VCO:** Set VC HE add-in to **Dual mode (EM boost)** mode
3. **SP/HEO:** Verify EM responds to manual throttle commands & ICE goes to 40%
4. **SP:** Increase throttle until RPA begins to taxi
5. **VCO:** Record min taxi throttle setting, min taxi speed, and engine speed
6. **SP:** Adjust throttle until controllable taxi achieved
7. **SP:** Taxi RPA for 4 laps
8. **VCO:** Place RPA in **Idle**

% Throttle (ICE) for min taxi: _____

Min taxi speed: _____

Min Engine Speed: _____

Current Draw: _____

% Throttle for taxi: _____

Taxi speed: _____

Taxi Engine Speed: _____

GT-04: PROCEDURES

Notes:

Dur: 30 min

Dual Mode (ICE Boost) Checkout

9. **VCO:** Set VC HE add-in throttle constant to 40% (EM will be 40%)** Reduce if needed
10. **VCO:** Set VC HE add-in to **Dual mode (ICE boost)** mode
11. **SP/HEO:** Verify ICE responds to manual throttle commands & EM goes to 40%
12. **SP:** Increase throttle until RPA begins to taxi
13. **VCO:** Record min taxi throttle setting, min taxi speed, and engine speed
14. **SP:** Adjust throttle until controllable taxi achieved
15. **SP:** Taxi RPA for 4 laps
16. **VCO:** Place RPA in **Idle**
17. **SP/HEO:** Kill RPA ICE
18. **HEO:** Record **engine stop time** and **ending fuel state**
19. **VCO/HEO/SP:** Proceed to Card **GT-05**

Current Draw: _____

% Throttle (EM) for min taxi: _____

Min taxi speed: _____

Min Engine Speed: _____

Current Draw: _____

% Throttle for taxi: _____

Taxi speed: _____

Taxi Engine Speed: _____

Current Draw: _____

Engine stop time: _____

Final Fuel State: _____

FT-05: CONDOR HE ICE Crossover & Cruise Test Card

Completed, Qualitatively, No Telemetry Data (interference issues), 15 February 2012

Preconditions:

Completion of GT-04

Note: Mission requires a Safety Observer (SO), HE System operator (HEO), and Virtual Cockpit operator (VCO). The entire test will be conducted in Manual Mode

CONDOR Configuration: 12-ft, 35 lbs, 18x10 2-blade prop

Objective:

Verify HE can transition manual control to autopilot and evaluate cruise performance

FT-05: PROCEDURES

Notes:

Dur: 30 min

HE System ICE Crossover Verification

1. **SO:** Ensure fire safety and test safety measures in place
2. **VCO:** Ensure CONDOR PID Values uploaded , and waypoints loaded into VC (vary speeds for ground testing)
3. **VCO:** Ensure VC in **Safe Mode** prior to HE-RPA startup
4. **HEO:** Record starting **fuel level** of RPA
5. **VCO:** Perform Pre-engine start-up portion of *Launch Checklist*
6. **VCO:** Verify RC Mode (control boxes grayed out) and in “**Manual Mode**”
7. **VCO:** Place VC HE add-in to **ICE only**
8. **HEO:** Conduct HE-RPA startup checklist, record **ICE start time**
9. **VCO:** Set VC HE add-in to **Dual Mode (ICE Boost)**, EM throttle constant (~30%)
10. **SP:** Accelerate RPA to approximated cruise speed (or appropriate for safe ground ops)

Starting Fuel Level: _____

ICE Start Time: _____

FT-05: PROCEDURES

Notes:

Dur: 30 min

11. **SP:** Begin test laps with RPA
12. **VCO:** Reduce EM throttle constant if directed by SP
13. **VCO:** Record **trim throttle** position, **trim airspeed**, and **engine speed**
14. **HEO:** Activate Crossover switch
15. **SP/VCO:** Verify autopilot has control of aircraft (Ice should respond to manual control in EM mode)
16. **HEO:** Deactivate Crossover switch
17. **SP/VCO:** RPA in back in manual control (back to Dual Mode)
18. **VCO:** Switch to **ICE only** mode (now in manual ICE mode)
19. **HEO:** Verify EM off
20. **HEO:** Activate crossover switch
21. **SP/VCO:** Verify autopilot has control of aircraft
22. **HEO:** Deactivate Crossover switch (Back to manual ICE)
23. **SP/VCO:** Monitor RPA under manual control for 10+ min grnd test, set to cruise velocity
24. **SP:** Recover RPA
25. **VCO:** Place VC in **Safe Mode**
26. **HEO:** Record **engine stop time** and **ending fuel state**
27. **VCO/HEO/SP:** Proceed to **Card GT-06**

Speed: _____**% Throttle:** _____**Engine Speed:** _____**Engine stop time:** _____**Final Fuel State:** _____

14. GT-07: CONDOR HE ReGen Mode & Kill Switch Test Card

Kill Tests Completed, Qualitatively, No Telemetry Data (interference issues), 15 February 2012
Regen not attempted due to interference issues during testing,

Preconditions:

Completion of GT-06

Note: Mission requires a Safety Observer (SO), HE System operator (HEO), and Virtual Cockpit operator (VCO). The entire test will be conducted in Manual Mode

CONDOR Configuration: 12-ft, 35 lbs, 18x10 2-blade prop

Objective:

Verify HE EM ReGen and ICE Kill switch function correctly

GT-07: PROCEDURES

Notes:

Dur: 30 min

HE System ReGen Verification

1. **SO:** Ensure fire safety and test safety measures in place
2. **VCO:** Ensure CONDOR PID Values uploaded , and waypoints loaded into VC
3. **VCO:** Ensure VC in **Safe Mode** prior to HE-RPA startup
4. **HEO:** Record battery starting **battery voltage & current**, ensure at least 2V under max
5. **HEO:** Record starting **fuel level** of RPA
6. **VCO:** Perform Pre-engine start-up portion of *Launch Checklist*
7. **VCO:** Verify RC Mode (control boxes grayed out) and in “**Manual Mode**”
8. **VCO:** Place VC HE add-in to **ICE Only**
9. **HEO:** Conduct HE-RPA startup checklist, record **ICE start time**
10. **VCO:** Set VC HE add-in to **Dual Mode (ICE Boost)**, EM throttle constant (~30%)

Starting Battery Voltage: _____ Starting Current: _____

Starting Fuel Level: _____

Start Engine Start Time: _____

GT-07: PROCEDURES

Notes:

Dur: 30 min

11. **SP:** Accelerate RPA to approximated cruise speed (or appropriate for safe grnd ops)
12. **SP:** Begin test laps with RPA
13. **VCO:** Reduce EM throttle constant is directed by SP
14. **VCO:** Record **trim throttle** position, **trim airspeed**, and **engine speed**
15. **VCO:** Set VC add-in to **ICE only Mode**
16. **HEO:** Verify EM off
17. **HEO:** Record Battery pack voltage & ReGen start time
18. **VCO:** Set VC add-in to **Regen Mode**
19. **HEO:** Maneuver RPA in lap pattern & monitor battery pack voltage, record time for voltage to increase 0.5V
20. **VCO:** Place VC HE add-in to **ICE Only**

****Simulated - HIGH RISK****

ICE Kill for Silent Operation

21. **VCO:** Set VC add-in to **EM Mode**
22. **HEO:** Verify EM powers up & ICE goes to idle
23. **SP:** Verify EM throttle response, prepare for simulated emergency landing
24. **HEO:** Activate **ICE Kill Switch**
25. **HEO:** Verify ICE killed & Record **engine stop time**
26. **SP:** Verify RPA performance under EM only mode (no ICE)

EM Kill verification

27. **HEO:** Activate EM kill switch just prior to touchdown

Starting Battery Voltage: _____

Start ReGen Time: _____

Pack Current: _____

Ending Battery Voltage: _____

End ReGen Time: _____

GT-07: PROCEDURES

Notes:

Dur: 30 min

28. **SP:** Recover ****Simulated Dead stick Landing****
29. **VCO:** Place VC in **Safe Mode**
30. **HEO:** Record **final fuel state**
31. **VCO/HEO/SP:** End Testing

Engine stop time: _____

Final Fuel State: _____

15. FT-00: CONDOR HE Kill Mode Verification Test Card

Preconditions:

Ground Control Station (GCS) set up and proper GCS operation verified. Ensure adequate support and safety measures in place.

Note: Mission requires a Safety Observer (SO), HE System operator (HEO), and Virtual Cockpit operator (VCO).

CONDOR Configuration: 12-ft, ____-lbs, 18x10 2-blade prop

Objective:

Verify HE system kill modes

FT-00: PROCEDURES

Notes:

Dur: 30 min

Kill mode verification

1. **SO:** Ensure fire safety and test safety measures in place
2. **VCO:** Ensure VC in **Safe Mode** prior to HE-RPA startup
3. **VCO:** Perform Pre-engine start-up portion of *Launch Checklist*
4. **VCO:** Verify RC Mode (control boxes grayed out) and in “**Manual Mode**”
5. **SO:** Ensure RPA is restrained & personnel have PPE
6. **HEO:** Conduct HE-RPA startup checklist
7. **VCO:** Set VC HE add-in to **ICE only** mode
8. **HEO:** Activate ICE kill switch
9. **HEO/VCO/SO:** Repeat steps 3-6

ICE killed: Yes / No

FT-00: PROCEDURES

Notes:

Dur: 30 min

10. **VCO:** Set VC HE add-in to **EM only** mode (ICE idle)
11. **HEO:** Activate EM kill switch
12. **VCO:** Place VC in **Safe Mode**
13. **SP/HEO/VCO:** Proceed to FT-01

EM killed: Yes / No

16. FT-01: CONDOR HE Dual Mode (ICE Boost) Flight Test Card

Preconditions:

Aircraft secured in test stand, HE system passed functional check, and Autopilot installation and ground configuration procedures accomplished as described in Section 1 through Section 2.1 of the Procerus Installation and Configuration Guide Document Version 2.0, dated 10/27/08. Autopilot mode control add-in verified via HE functional check. Ensure adequate support and safety measures in place.

Note: Mission requires a Safety Observer (SO), HE System operator (HEO), and Virtual Cockpit operator (VCO). The entire test will be conducted in Manual Mode

CONDOR Configuration: 12-ft, ____-lbs, 18x10 2-blade prop

Objective:

Verify takeoff & flight performance of integrated HE system in dual (ICE Boost) mode

FT-01: PROCEDURES	Notes: Dur: 30 min
<p><u>Takeoff & Dual Mode (ICE boost)</u></p> <ol style="list-style-type: none"> 1. SO: Ensure fire safety and test safety measures in place 2. VCO: Ensure CONDOR PID Values uploaded , and waypoints/rally points loaded into VC 3. VCO: Ensure VC in Safe Mode prior to HE-RPA startup 4. HEO: Record starting <u>fuel level</u> of RPA 5. HEO: Record starting <u>battery voltage</u> and <u>current draw</u> 6. VCO: Perform Pre-engine start-up portion of <i>Launch Checklist</i> 7. VCO: Verify RC Mode (control boxes grayed out) and in “Manual Mode” 	<p>Starting Fuel Level: _____</p> <p>Starting battery voltage:____ Starting Current Draw:_____</p>

FT-01: PROCEDURES

Notes:

Dur: 30 min

8. **HEO:** Conduct HE-RPA startup checklist, record **ICE start time**
9. **VCO:** Set VC HE add-in to **Dual Mode (ICE Boost)**
10. **SP:** Launch aircraft
11. **SP:** Trim the CONDOR for level flight at 700 ft
12. **VCO:** Record **trim throttle** position, **trim airspeed**, and **engine speed**
13. **SP:** Fly minimum 4 laps around airfield
14. **VCO/HEO/SP:** Proceed to **Card FT-02**

ICE Start Time: _____**Trim Airspeed:** _____**% Throttle trim:** _____**Engine Speed:** _____

17. FT-02: CONDOR HE ICE Mode Flight Test Card

Preconditions:

Completion of FT-01, RPA in trimmed & stable flight, in Dual Mode (ICE Boost)

Note: Mission requires a Safety Observer (SO), HE System operator (HEO), and Virtual Cockpit operator (VCO). The entire test will be conducted in Manual Mode

CONDOR Configuration: 12-ft, ____-lbs, 18x10 2-blade prop

Objective:

Verify performance of integrated HE system in ICE only mode

FT-02: PROCEDURES

Notes:

Dur: 30 min

ICE Mode Checkout (ICE Boost – ICE Only – EM Only)

1. **SP/VCO:** Verify RPA trimmed at 700 ft and in dual mode
2. **VCO:** Set VC HE add-in mode to **ICE only**
3. **SP:** Recover RPA to 700ft and trimmed flight if needed
4. **HEO:** Verify EM off
5. **VCO:** Record **trim throttle** position, **trim airspeed**, and **engine speed**
6. **SP:** Complete 4 laps around airfield
7. **VCO:** Set VC HE add-in mode to **EM Only**
8. **HEO:** Verify ICE goes to idle
9. **VCO/HEO/SP:** Proceed to **Card FT-03**

Trim Airspeed: _____

% Throttle trim: _____

Engine Speed: _____

18. FT-03: CONDOR HE EM Mode Flight Test Card

Preconditions:

Completion of FT-02, RPA in trimmed & stable flight, in EM Mode

Note: Mission requires a Safety Observer (SO), HE System operator (HEO), and Virtual Cockpit operator (VCO). The entire test will be conducted in Manual Mode

CONDOR Configuration: 12-ft, ____-lbs, 18x12 2-blade prop

Objective:

Verify performance of integrated HE system in EM only mode

FT-03: PROCEDURES

Notes:

Dur: 30 min

EM Mode Checkout (EM Only – ICE Only)

1. **SP/VCO:** Verify RPA trimmed at 700 ft and in EM Only mode
2. **VCO:** Set VC HE add-in mode to **ICE Only**
3. **SP:** Recover RPA to 700ft and trimmed flight if needed
4. **HEO:** Verify EM off
5. **VCO:** Record **trim throttle** position, **trim airspeed**, and **engine speed**
6. **SP:** Complete 4 laps around airfield
7. **VCO/HEO/SP:** Proceed to **Card FT-04**

Trim Airspeed: _____

% Throttle trim: _____

Engine Speed: _____

19. FT-04: CONDOR HE Dual Mode Flight Test Card

Preconditions:

Completion of FT-03, RPA in trimmed & stable flight, in ICE Mode

Note: Mission requires a Safety Observer (SO), HE System operator (HEO), and Virtual Cockpit operator (VCO). The entire test will be conducted in Manual Mode

CONDOR Configuration: 12-ft, ____-lbs, 18x10 2-blade prop

Objective:

Verify performance of integrated HE system in Dual mode

FT-04: PROCEDURES

Notes:

Dur: 30 min

Dual Mode Checkout (ICE – EM Boost)

1. **SP/VCO:** Verify RPA trimmed at 700 ft and in ICE mode
2. **VCO:** Set **Dual mode** throttle constant to 10% above ICE idle (~ 40%)
3. **VCO:** Set VC HE add-in mode to **Dual mode (EM Boost)**
4. **SP:** Verify EM throttle control, Recover RPA to 700ft and trimmed flight if needed
5. **HEO:** Verify ICE at constant setting (~40%) – step 2
6. **VCO:** Record **trim throttle** position, **trim airspeed**, and **engine speed**
7. **SP:** Complete 4 laps around airfield
8. **SP:** Conduct landing approach to determine necessary throttle settings
9. **VCO:** Reduce Dual mode throttle constant if directed by SP
10. **SP:** Recover/Land RPA
11. **HEO:** Record **engine stop time** and **ending fuel state**
12. **VCO/HEO/SP:** Proceed to **Card FT-05**

Trim Airspeed: _____

% Throttle trim: _____

Engine Speed: _____

Engine stop time: _____

Final Fuel State: _____

FT-05: CONDOR HE ICE Crossover & Cruise Test Card

Preconditions:

Completion of FT-04

Note: Mission requires a Safety Observer (SO), HE System operator (HEO), and Virtual Cockpit operator (VCO). The entire test will be conducted in Manual Mode

CONDOR Configuration: 12-ft, ____-lbs, 18x10 2-blade prop

Objective:

Verify HE can transition manual control to autopilot and evaluate cruise performance

FT-05: PROCEDURES

Notes:

Dur: 30 min

HE System ICE Crossover Verification

1. **SO:** Ensure fire safety and test safety measures in place
2. **VCO:** Ensure CONDOR PID Values uploaded , and waypoints/rally points loaded into VC
3. **VCO:** Ensure VC in **Safe Mode** prior to HE-RPA startup
4. **HEO:** Record starting **fuel level** of RPA
5. **HEO:** Record starting **battery voltage** and **current draw**
6. **VCO:** Perform Pre-engine start-up portion of *Launch Checklist*
7. **VCO:** Verify RC Mode (control boxes grayed out) and in “**Manual Mode**”
8. **HEO:** Conduct HE-RPA startup checklist, record **ICE start time**

Starting Fuel Level: _____

Starting battery voltage:_____ **Starting Current Draw:**_____

FT-05: PROCEDURES

Notes:

Dur: 30 min

9. **VCO:** Set VC HE add-in to **Dual Mode (ICE Boost)**, EM throttle constant (~40%)
10. **SP:** Launch aircraft
11. **SP:** Trim the CONDOR for level flight at 700 ft
12. **VCO:** Reduce EM throttle constant is directed by SP
13. **VCO:** Record trim throttle position, trim airspeed, and engine speed
14. **HCO:** Activate Crossover switch
15. **SP/VCO:** Verify autopilot has control of aircraft
16. **HCO:** Deactivate Crossover switch
17. **SP/VCO:** RPA in back in manual control (back to Dual Mode)
18. **VCO:** Switch to ICE only mode
19. **HCO:** Activate crossover switch
20. **HCO:** Verify EM off
21. **SP/VCO:** Monitor RPA under autopilot control for 10+ min flight, set to cruise velocity
22. **HCO:** Activate Crossover switch
23. **SP:** Recover/Land RPA
24. **VCO:** Place VC in **Safe Mode**
25. **HCO:** Record engine stop time and ending fuel state
26. **VCO/HCO/SP:** Proceed to **Card FT-06**

ICE Start Time: _____**Trim Airspeed:** _____**% Throttle trim:** _____**Engine Speed:** _____**Engine stop time:** _____**Final Fuel State:** _____

20. FT-06: CONDOR Endurance Test Card

Preconditions:

Completion of FT-05

Note: Mission requires a Safety Observer (SO), HE System operator (HEO), and Virtual Cockpit operator (VCO). The entire test will be conducted in Manual Mode

CONDOR Configuration: 12-ft, ____-lbs, 18x10 2-blade prop

Objective:

Verify HE can transition manual control to autopilot and evaluate endurance performance

FT-06: PROCEDURES

1. **SO:** Ensure fire safety and test safety measures in place
2. **VCO:** Ensure CONDOR PID Values uploaded , and waypoints/rally points loaded into VC
3. **VCO:** Ensure VC in **Safe Mode** prior to HE-RPA startup
4. **HEO:** Record starting **fuel level** of RPA
5. **HEO:** Record starting **battery voltage** and **current draw**
6. **VCO:** Perform Pre-engine start-up portion of *Launch Checklist*
7. **VCO:** Verify RC Mode (control boxes grayed out) and in “**Manual Mode**”
8. **HEO:** Conduct HE-RPA startup checklist, record **ICE start time**
9. **VCO:** Set VC HE add-in to **Dual Mode (EM Boost)**, ICE throttle constant (~40%)

Notes:

Dur: 30 min

Starting Fuel Level: _____

Starting battery voltage: _____ **Starting Current Draw:** _____

FT-06: PROCEDURES

Notes:

Dur: 30 min

10. **SP:** Launch aircraft
11. **SP:** Trim the CONDOR for level flight at 700 ft
12. **VCO:** Reduce ICE throttle constant is directed by SP
13. **VCO:** Record **trim throttle** position, **trim airspeed**, and **engine speed**
14. **SP/VCO:** RPA in back in manual control (back to Dual Mode)
15. **VCO:** Switch to EM only mode
16. **HEO:** Verify ICE idle
17. **SP/VCO:** Monitor RPA under autopilot control for 10+ min flight, set to endurance velocity
18. **SP:** Recover/Land RPA
19. **VCO:** Place VC in **Safe Mode**
20. **HEO:** Record **engine stop time** and **ending fuel state and required battery charge**
21. **VCO/HEO/SP:** Proceed to **Card FT-06**

ICE/EM Start Time: _____**Trim Airspeed:** _____**% Throttle trim:** _____**Engine Speed:** _____**Engine stop time:** _____**Final Fuel State:** _____**Required Battery Charge:** _____

21. FT-07: CONDOR HE ReGen Mode & Kill Switch Test Card

Preconditions:

Completion of GT-06

Note: Mission requires a Safety Observer (SO), HE System operator (HEO), and Virtual Cockpit operator (VCO). The entire test will be conducted in Manual Mode

CONDOR Configuration: 12-ft, ____-lbs, 18x10 2-blade prop

Objective:

Verify HE EM ReGen and ICE Kill switch function correctly

FT-07: PROCEDURES

Notes:

Dur: 30 min

HE System ReGen Verification

1. **SO:** Ensure fire safety and test safety measures in place
2. **VCO:** Ensure Condor PID Values uploaded , and waypoints loaded into VC
3. **VCO:** Ensure VC in **Safe Mode** prior to HE-RPA startup
4. **HEO:** Record battery starting **battery voltage & current**, ensure at least 2V under max
5. **HEO:** Record starting **fuel level** of RPA
6. **VCO:** Perform Pre-engine start-up portion of *Launch Checklist*
7. **VCO:** Verify RC Mode (control boxes grayed out) and in “**Manual Mode**”
8. **VCO:** Place VC HE add-in to **ICE Only**
9. **HEO:** Conduct HE-RPA startup checklist, record **ICE start time**

Starting Battery Voltage: _____ Starting Current: _____

Starting Fuel Level: _____

FT-07: PROCEDURES

Notes:

Dur: 30 min

10. **VCO:** Set VC HE add-in to **Dual Mode (ICE Boost)**, EM throttle constant (~30%)
11. **SP:** Accelerate RPA to approximated cruise speed (or appropriate for safe grnd ops)
12. **SP:** Begin test laps with RPA
13. **VCO:** Reduce EM throttle constant is directed by SP
14. **VCO:** Record **trim throttle** position, **trim airspeed**, and **engine speed**
15. **VCO:** Set VC add-in to **ICE only Mode**
16. **HEO:** Verify EM off
17. **HEO:** Record Battery pack voltage & ReGen start time
18. **VCO:** Set VC add-in to **Regen Mode**
19. **HEO:** Maneuver RPA in lap pattern & monitor battery pack voltage, record time for voltage to increase 0.5V
20. **VCO:** Place VC HE add-in to **ICE Only**

****Simulated - HIGH RISK****

ICE Kill for Silent Operation

21. **VCO:** Set VC add-in to **EM Mode**
22. **HEO:** Verify EM powers up & ICE goes to idle
23. **SP:** Verify EM throttle response, prepare for simulated emergency landing
24. **HEO:** Activate **ICE Kill Switch**
25. **HEO:** Verify ICE killed & Record **engine stop time**
26. **SP:** Verify RPA performance under EM only mode (no ICE)

EM Kill verification

Start Engine Start Time: _____

Battery Voltage: _____ **Start ReGen Time:** _____

End ReGen Time: _____

Engine stop time: _____

FT-07: PROCEDURES

Notes:

Dur: 30 min

27. **HEO:** Activate EM kill switch just prior to touchdown
28. **SP:** Recover ****Simulated Dead stick Landing****
29. **VCO:** Place VC in **Safe Mode**
30. **HEO:** Record **final fuel state**
31. **VCO/HEO/SP:** End Testing

Final Fuel State: _____

Appendix J. Qualitative Risk Assessment

Flight Test Approval

- Description

In order to fly a UAV, Federal Aviation Administration (FAA) and military requirements must be met. Since the RPAs were being built using OSD funding, USAF/AFRL requirements did not apply to the unmodified version of the RPA. Since AFRL funding was used to develop the HE system, the HE-RPA may have required approval from AFRL prior to all flight tests.

- Planned Mitigation efforts

We planned to fly the unmodified RPA and HE-RPA in restricted airspace so that there were fewer FAA restrictions. We also worked with AFRL subject matter experts and other AFIT organizations that had used the AFRL process to learn of possible pitfalls.

- Impact

Without AFRL approval, we may not have been able to fly the HE-RPA. Even with AFRL approval, flight tests may have been delayed due to “red tape”.

- Results

Working with AFRL ahead of time assisted in clarifying the AFRL involvement in the project. AFRL decided that since AFRL funds were only used for HE development, and not directly used for flight testing, AFRL approval was not required for the flight testing.

HE development/Configuration

- Description

The HE system had not yet run with the gas and electric motors working in tandem. The configuration of the HE system that would eventually be integrated into the modified RPA had not been determined at project initiation. The HE configuration could have impacted: noise, weight, efficiency, thrust etc.

- Planned Mitigation efforts

This was a primary portion of the hybrid-electric research. Additional team members were hired to continue to develop the HE system and have it running in the intended configuration of the HE-RPA prior to delivery of the Condor airframes. The HE system was also primarily comprised of commercial off the shelf (COTS) components resulting in a shorter planned development time.

- Impact

HE development and system configuration was critical to this project and poor planning and execution here could have impacted cost, schedule, and performance.

- Results

The additional team members were unable to fully develop the HE system in accordance with the pre-planned schedule, because the maturity of the HE technology development was not as high as originally understood. There were also many unforeseen setbacks in the development and integration of the HE system that are discussed in detail

by Ausserer [12]. Although using COTS items assisted in reducing HEPS development cost and schedule, they were also used in ways that were not intended by the original equipment manufacturer (OEM), causing many of the unforeseen setbacks.

Risk of crashing an airplane

- Description

As with all aviation systems, there was a risk of crashing one or both RPAs. Since program funding was limited, it was not feasible to have spare RPAs available in case of catastrophic failure. It was initially anticipated that the HE-RPAs would have hard landings since there was a plan to use fall-away landing gear.

- Planned Mitigation efforts

The flight test approval activities were modeled after the AFRL process for the unmodified RPA. By following the value added portions of the AFRL flight test approval process, the HE-RPA development team planned to mitigate flight risk via simulation and quality test planning.

By having two identical RPAs to work with, program risk could have been reduced by utilizing interchangeable parts between the two RPAs so that if a portion of one aircraft were broken during a rough landing, then a part from the other aircraft could have been used to get it back in the air for testing. The HE-RPA development team also planned to work with CLMax in order to use residual contract funding to procure spare parts for contingency purposes.

- Impact

Should both RPAs have had catastrophic landings or failures resulting in un-repairable damage, then the impact to some of the test objectives would have been critical. Test objectives were accomplished according to flight risk so that less risky objectives were accomplished first. It was expected that some rough landings would happen. If a rough landing happened during testing and the RPA was not repairable in the field, then testing for that test objective may have been delayed until the next test activity.

- Results

The HE-RPA team decided to keep the landing gear on the aircraft at all times mitigating the impact of rough landings. Some rough landings occurred and the spare parts provided by CLMax assisted in repairing the aircraft in time for the next test event. By prioritizing test activities and accomplishing lower risk tests first, the rough landings that did occur did not cause significant schedule delays. By analyzing the cracks caused by rough landings, the team determined areas where the aircraft required more structural integrity. Between flight test events, the aircraft structure was reinforced to protect against damage caused during future rough landings.

Further Fabrication Shop Delays

- Description

The original version of the RPA was to be built by CLMax. If there were a delay in the fabrication of the RPA then it could have caused a program delay.

- Planned Mitigation efforts

The HE-RPA development team planned to work with CLMax to ensure that the parts that we required early in the schedule were manufactured first. The team also planned on getting regular progress updates from CLMax.

- Impact

Based on the initial schedule, RPA delivery was not on the critical path and so some delay was acceptable.

- Results

Fabrication of the RPA's was delayed but did not get on the critical path. The team requested that the fuselage of the HE-RPA be sent earlier in order to expedite the integration of the HE system in the fuselage. The fuselage that was shipped ended up being an extra fuselage that was used to repair the aircraft after several rough landings. Although the extra fuselage was ordered to mitigate the integration risk, it actually mitigated the risk of rough landings and did not result in mitigation to the integration schedule risk.

When discussing the progress of airframe fabrication with CMax, CLMax explained that after several flight test attempts, the fabrication prototype aircraft did not fly. CLMax requested more time to develop the airframe so that a two cycle engine could be ordered and replaced in the prototype airframe for further flight test events. The

HE-RPA development team determined that the proposed schedule delay resulting from an integration of a two cycle engine was not worth the potential to gather more information about the prototype airframe.

The development team knew that the airfoil being used was a proven airfoil and was stumped as to why the prototype airframe did not fly. The team requested that CLMax deliver the airframes as planned even though the flight potential was unproven. The team decided to accept the technical risk of having an unproven airframe in exchange for the shorter delivery schedule. The team felt that the group of aeronautical engineers involved in the project with the assistance of aeronautical engineering professors and CESI support contractors would be able to get the airframe to fly. The team knowingly agreed to pay CLMax for two airframes that may never fly and understood that the majority of test objectives would not be accomplished if the airframes were not capable of flying.

Feedback Control

- Description

The HE-RPA needed to be controllable during flight tests. As this was a new platform, the feedback control was expected to be nontrivial.

- Planned Mitigation efforts

The HE-RPA development team assumed that CLMax would design the original feedback control of the RPA as part of RPA development. As control is an iterative process, the team planned to first tune the control loops of the original RPA prior to tuning the control loops of the HE-RPA.

- Impact

According to the initial schedule, feedback control should not have had a great impact on the program schedule but could have impacted the flight test schedule.

- Results

CLMax was not able to successfully get the aircraft off the ground prior to delivery of the aircraft. The fuselage fabrication was delayed several months and CLMax requested additional time to try a different engine. The HE-RPA team decided to request that CLMax deliver the Condor air frames and let the team figure out how to get them off the ground after delivery. Since CLMax never flew the Condor, CLMax did not assist in the design of the feedback control of the Condor aircraft. Giacomo [13] discusses the development of the feedback control, via control loop tuning, of the Condor.

Development of the feedback control did not delay the development of the HE-RPA since

Giacomo was able to tune the gains for the ICE RPA at the weight of the HE-RPA and use those gains for the HE-RPA.

Propeller Type

- Description

It was expected that some propellers were more likely to break during landing and some propellers were quieter than others.

- Planned Mitigation efforts

The HE-RPA development team researched propeller noise based on propeller type and will use a quiet propeller that was inexpensive so that we can afford to have spare propellers during testing.

- Impact

Propeller noise could have had a significant impact on mission performance. Propeller type may have had a minimal impact on cost if they break during landings more often than expected.

- Results

A test stand was set up to test the noise of potential propellers. Propeller noise continues to be an issue with regards to the quiet operation of the HE-RPA. Although the engine noise can be reduced using an HEPS, the propeller noise will continue to be an issue.

Appendix K. Test and Evaluation Management Plan (TEMP)

**TEST AND EVALUATION MASTER PLAN
FOR
HYBRID ELECTRIC REMOTELY PILOTED AIRCRAFT
HE-RPA
ACAT Level N/A**

SUBMITTED BY

Michael Molesworth, Capt USAF
Program Manager

09 Aug 2011
DATE

AF Institute of Technology
Program Executive Officer

09 Aug 2011
DATE

or Developing Agency (if not under the Program Executive Officer structure)

TABLE OF CONTENTS

PART 1 – INTRODUCTION

- 1.1 PURPOSE
- 1.2 MISSION DESCRIPTION
- 1.3 SYSTEM DESCRIPTION
 - 1.3.1 System Threat Assessment
 - 1.3.2 Program Background
 - 1.3.2.1 Previous Testing
 - 1.3.3 Key Capabilities
 - 1.3.3.1 Key Interfaces
 - 1.3.3.2 Special test or certification requirements
 - 1.3.3.3 Systems Engineering (SE) Requirements

PART II – TEST PROGRAM MANAGEMENT AND SCHEDULE

- 2.1 T&E MANAGEMENT
 - 2.1.1 T&E Organizational Construct
- 2.2 COMMON T&E DATA BASE REQUIREMENTS
- 2.3 DEFICIENCY REPORTING
- 2.4 TEMP UPDATES
- 2.5 INTEGRATED TEST PROGRAM SCHEDULE
 - Figure 2.1 – Integrated Test Program Schedule

PART III – TEST AND EVALUATION STRATEGY

- 3.1 T&E STRATEGY
- 3.2 EVALUATION FRAMEWORK
 - Figure 3.1 – Top-Level Evaluation Framework Matrix
- 3.3 DEVELOPMENTAL EVALUATION APPROACH
 - 3.3.1 Mission-Oriented Approach
 - 3.3.2 Developmental Test Objectives
 - 3.3.3 Modeling and Simulation
 - 3.3.4. Test Limitations
- 3.4 LIVE FIRE EVALUATION APPROACH

- 3.4.1 Live Fire Test Objectives
- 3.4.2 Modeling and Simulation
- 3.4.3 Test Limitations
- 3.5 CERTIFICATION FOR IOT&E
 - 3.5.1 Assessment of Operational Test Readiness
- 3.6 OPERATIONAL EVALUATION APPROACH
 - 3.6.1 Operational Test Objectives
 - 3.6.2 Modeling and Simulation
 - 3.6.3 Test Limitations
- 3.7 OTHER CERTIFICATIONS
- 3.8 RELIABILITY GROWTH
- 3.9 FUTURE TEST AND EVALUATION

PART IV – RESOURCE SUMMARY

- 4.1 INTRODUCTION
 - 4.1.1 Test Articles
 - 4.1.2 Test Sites and Instrumentation
 - 4.1.3 Test Support Equipment
 - 4.1.4 Threat Representation
 - 4.1.5 Test Targets and Expendables
 - 4.1.6 Operational Force Test Support
 - 4.1.7 Models, Simulations, and Test-beds
 - 4.1.8 Joint Operational Test Environment
 - 4.1.9 Special Requirements
- 4.2 FEDERAL, STATE, LOCAL REQUIREMENTS
- 4.3 MANPOWER/PERSONNEL TRAINING
- 4.4 TEST FUNDING SUMMARY

Table 4.1 Resource Summary Matrix

APPENDIX A – BIBLIOGRAPHY

APPENDIX B – ACRONYMS

APPENDIX C – POINTS OF CONTACT

1. PART I - INTRODUCTION

1.1. Purpose.

The purpose of this TEMP is to set forth the planning and actions required to evaluate the effectiveness of the Condor Remotely Piloted Aircraft (RPA), a small unmanned air vehicle powered by a hybrid-electric propulsion system. This submission is the initial version of the TEMP. This TEMP is intended to support a potential Milestone-A decision; associated with an Air Force Institute of Technology Systems Engineering Master's Degree program. Testing is intended to evaluate performance characteristics documented in the Hybrid-Electric RPA CONOPS.

1.2. Mission Description.

The proposed concept is intended to fulfill the need for a forward deployed, near-silent, ISR collection platform capable of providing sustained ISR data collection for utilization in planning, real time operations, or post operation analysis. The concept is intended to utilize payloads designed for low altitude operations, while being operated from a safe standoff distance. Units equipped with the system are anticipated to operate the system in accordance with the included OV-1 illustrated in the CONOPS (ref) and system architecture (ref).

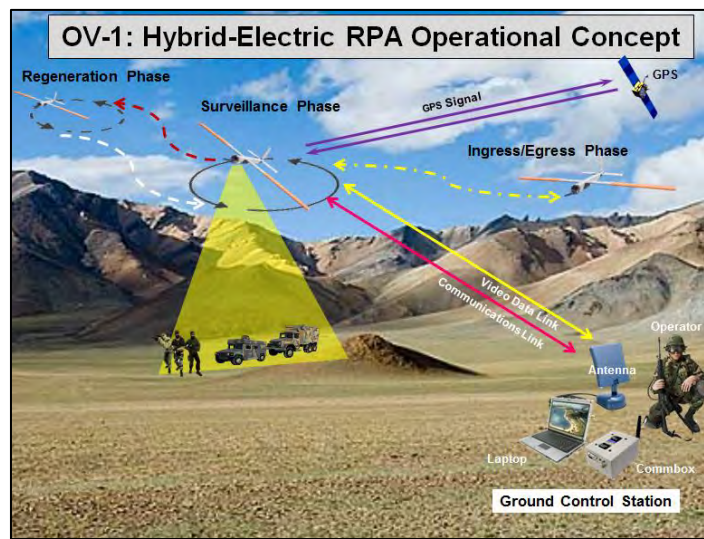

1.3. System Description.

The HE-RPA will consist of a glider-like airframe with both 12 and 15 foot wingspan configurations. The project will have two airframes, one with a hybrid-electric propulsion system and one with an internal combustion engine (ICE). The purpose of the aircraft with the ICE propulsion system will be to provide a performance baseline against which the hybrid-electric airframe will be compared. The ICE-RPA will consist of the ICE propulsion system, the basic airframe, the Kestral Autopilot, a gas tank, and an onboard camera. The HE-RPA will consist of the HE propulsion system, the basic airframe, the Kestral Autopilot, the gas tank, an onboard camera, LiPo Batteries, and the engine throttle and mode controller.

1.3.1. System Threat Assessment.

In an operational environment, the HE-RPA will be exposed to environmental hazards as well as enemy small arms fire and counter measures. The as-built configurations will not include any form of communications or data link security measures, leaving the system vulnerable to signal pirating and/or hacking. The enemy may be able to duplicate the ground control protocol and take control of the aircraft in the as-built configuration. IT is anticipated that HE-RPA communication protocols will be secure in the as-intended configuration and comply with Defense Intelligence Agency mandated measures.

1.3.2. Program Background.

Although this effort is primarily focused on determining the potential operational viability of a HE-RPA concept as a master's level academic program, the basis for the project lays in several PhD and masters level research efforts done at UC Davis, AFIT, and AFRL. These previous efforts were primarily focused on airframe and propulsion system development and optimization. Due to the academic environment in which the HE-RPA will be developed, the academic portion of this project will be accomplished by producing and evaluating a unique configuration, the "as-built" configuration, and extending that evaluation to an "as-intended" or potentially operational configuration. The "as-built" configuration will be a simplified version of the "as-intended"

configuration. This project will serve as a proof of concept to determine if the HE-RPA concept is a viable alternative for long loiter near-silent ISR collection operations. It is anticipated that future students may further develop this concept.

1.3.2.1. Previous Testing.

Many of the individual components comprising the HE propulsion system have been tested. The HE propulsion system is currently under development at AFIT with assistance from AFRL and has completed some initial ground testing for some of the operating modes. Initial ground testing of the camera has also been accomplished. The provider of the airframe, CLMax, has built a prototype of the ICE-RPA platform but unable to get it off the ground during initial flight testing. The airframe testing results thus far have led to the parallel development of a catapult launch system and the necessary test planning.

1.3.3. Key Capabilities.

KPP	Threshold	Objective
1. HE-RPA quieter than Existing ICE-RPAs	HE-RPA noise level equal to ICE RPA idle noise level	HE-RPA noise level less than 70dB
2. Loitering time exceeding unmodified ICE-RPA	HE-RPA loiter time exceeding ICE idle fuel burn rate for 60oz	HE-RPA loiter time doubling ICE idle fuel burn rate for 60oz
3. Loitering time comparable to existing ICE-RPAs	HE-RPA loiter time 30-min	HE-RPA loiter time 2 hours
4. Runway Takeoff Distance	150 ft. (use of catapult okay)	120 ft. without catapult assistance

1.3.3.1. Key Interfaces.

Successful operation of the HE RPA requires interfacing of key elements including both system and non-system components. These key system and non-system elements are shown in Table 1 and depicted in the Systems Viewpoint 1 (SV-1) of the systems architecture.

Table 1: System Elements

System Elements	Non-System Elements
Aircraft	Command and Control
Ground Control Station	Global Positioning System (GPS)
Manual Backup Control	Environment
Operator	

(SV-1)

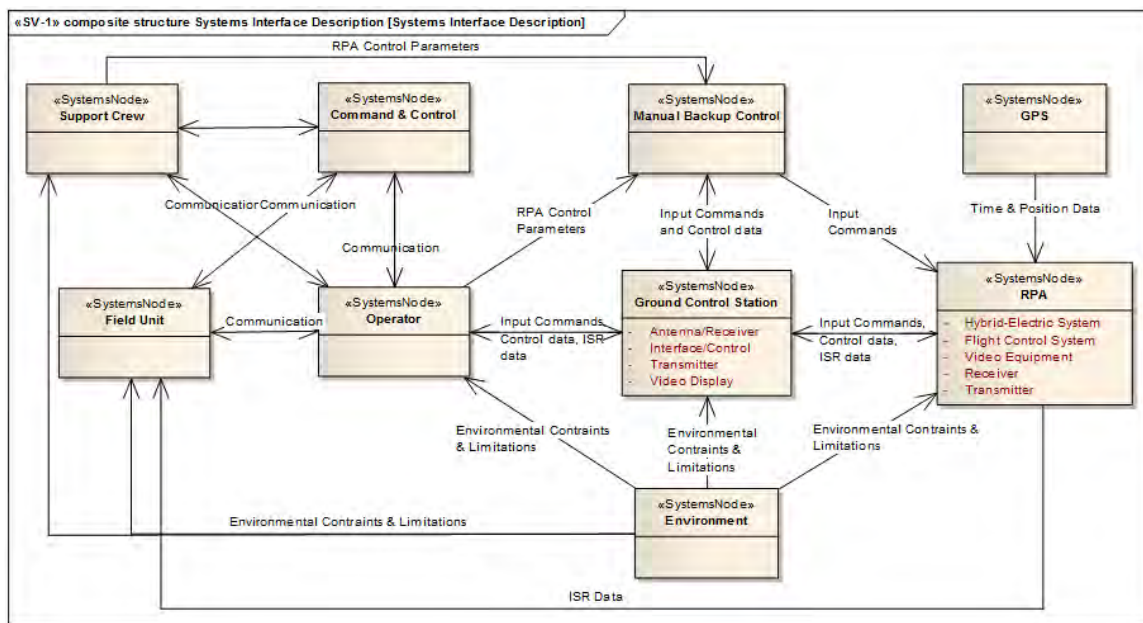

1.3.3.2. Special test or certification requirements. N/A

1.3.3.3. Systems Engineering (SE) Requirements.

Due to the project duration, the system under development will only attain a prototype status. Therefore, testing will be limited to Type 1 testing per Blanchard and Fabrycky 2011. Type 1 testing is tailored towards evaluating engineering test models, system components, breadboards, mock-ups, and rapid prototyping. The systems

engineering plan (SEP) is tailored to allow for incremental component development and test, culminating in overall [prototype] system test and evaluation (T&E). System evaluation targets will be derived from SE-based information including the initial system level requirements, measures of effectiveness (MOEs) (ref), key performance parameters (KPPs) (ref), and subsystem/component specifications (ref).

2. PART II – TEST PROGRAM MANAGEMENT AND SCHEDULE

2.1 T&E Management.

All test management activities, to include planning, scheduling, resource allocation, and documentation will be the responsibility of and conducted by AFIT graduate students fulfilling roles of government developmental testers.

Initial developmental testing of a base airframe will be conducted by the contractor, CLMax. The contractor is responsible for delivering an airworthy vehicle capable of incorporating the hybrid-electric propulsion system. Results of this preliminary testing will be utilized for further HE-RPA prototype development and flight control optimization.

Additionally, graduate students from AFIT along with local undergraduate interns will fabricate the hybrid-electric propulsion system and conduct developmental testing. The results of the propulsion system testing will be used to validate previous HE-RPA analyses, the feasibility of multi-mode operation, and the potential viability of a proposed operational concept.

Flight testing and vehicle ground testing will be accomplished by graduate students with support provided by CESE (ref), an engineering support contractor. The support contractor is responsible for providing safety pilots, basic flight test support, visual spotting, ground station setup, and basic vehicle and support equipment maintenance.

2.1.1. T&E Organizational Construct.

Key testing activities and the associated organizational construct for the testing is depicted below. System testing will essentially fall into one of three broad divisions; Hybrid-Electric propulsion system developmental test, airframe/vehicle testing, and system integration testing. Testing will be limited to developmental in scope. No follow-on OT&E is planned nor is any LFT&E necessary or planned as this is an unmanned system. Testing has also been organized in such a manner as to facilitate the necessary division of labor and scope needed for specific yet various AFIT master's degree requirements.

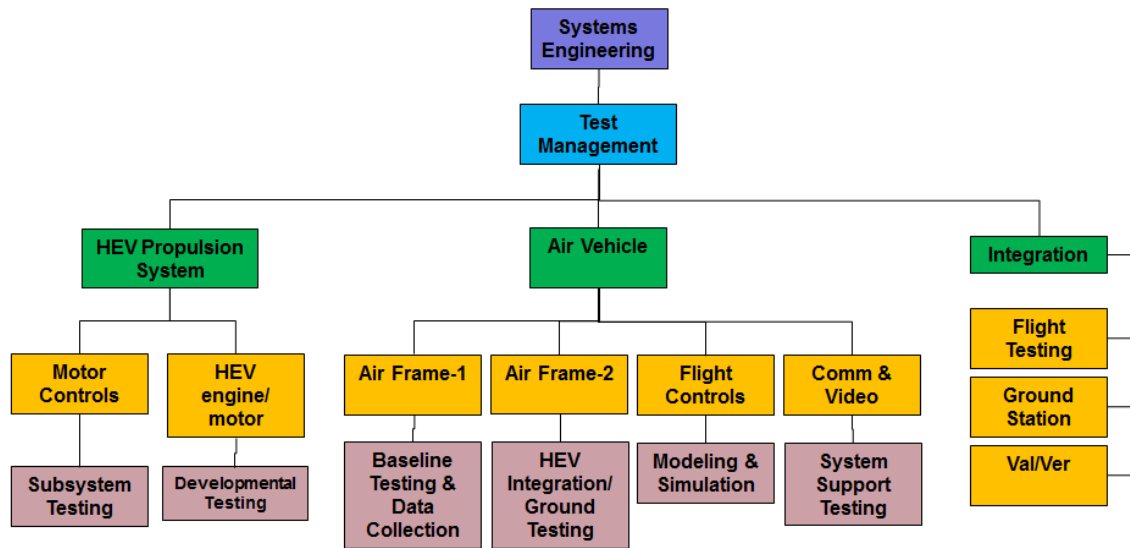

2.2. Common T&E Database Requirements.

Testing will be documented in accordance with specifics detailed in specific test plans and per pre-determined developmental testing criteria. T&E data will be stored in the AFIT shared Condor file at L:\Students\Groups\GSE_Group_Research\Condor. Results of testing and the final concept evaluation will also be documented in the pertinent AFIT master's theses.

2.3. Deficiency Reporting

Deficiencies will be reported and documented IAW test plans and after action reports/summations. Dissemination will be via update emails or during weekly project

reviews. The reports will include a description of the problem as well as one or more proposed solutions.

2.4. TEMP updates

The latest version of the TEMP will be posted in the L:\Students\Groups\GSE_Group_Research\Condor file. The TEMP will be used as a “living” document and will be updated as required throughout the project. The TEMP will be reviewed prior to all scheduled testing

2.5. Integrated Test Program Schedule.

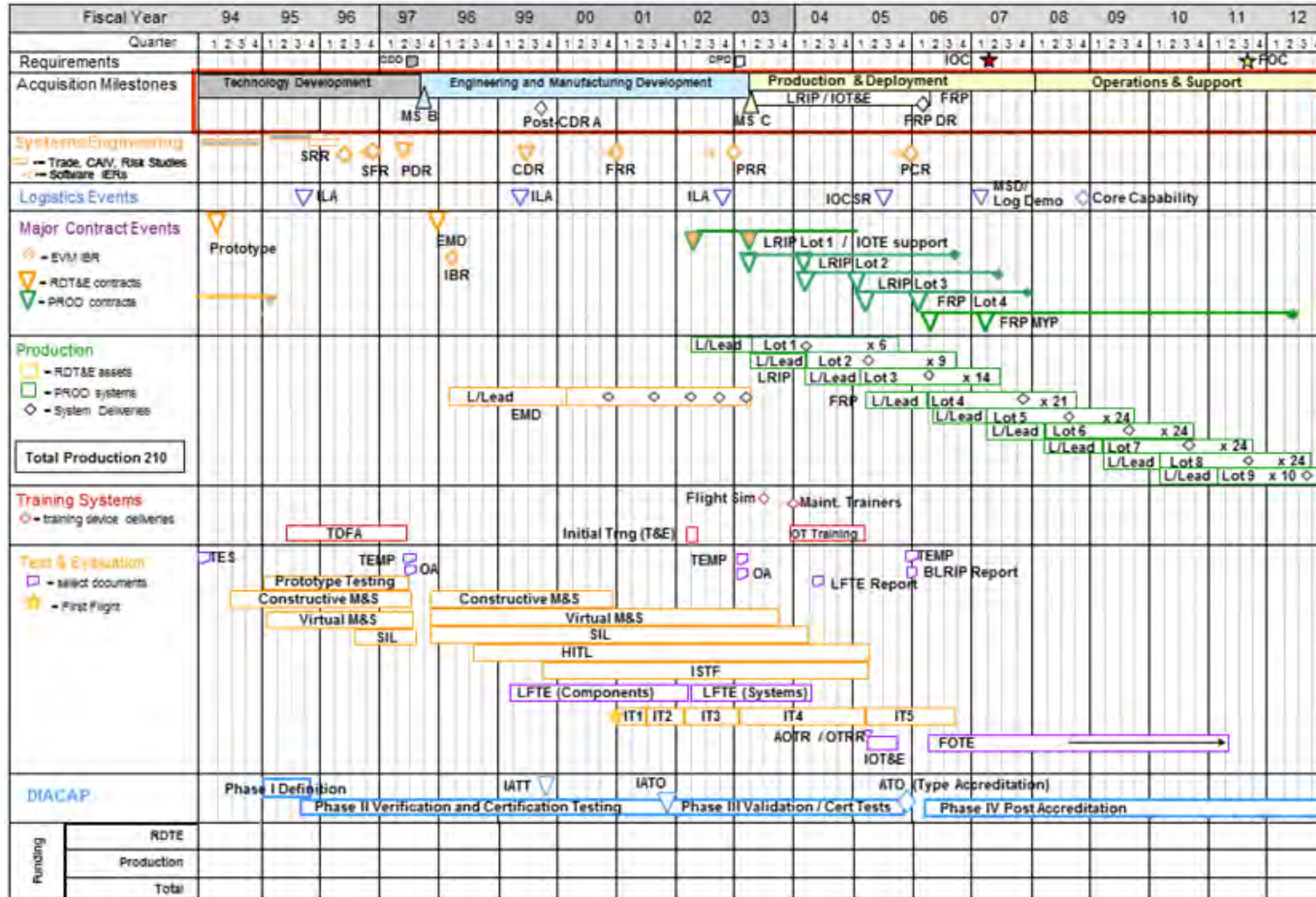

3. PART III – TEST AND EVALUATION STRATEGY

3.1 T&E Strategy

The primary purpose of testing this system is to collect information needed to generate a concept evaluation for a remotely piloted aircraft powered by a hybrid-electric propulsion system. Testing will also facilitate a piecemeal evaluation of component technologies including the standalone hybrid-electric propulsion system, the RPA platform, the ground control station, and the control logic/strategies. Testing will also contribute to the development of future employment tactics for this system.

The concept evaluation could potentially support a transition of the system into an official acquisition program (pre milestone A) or it may contribute to the future development and/or advancement of related technologies.

Testing will follow a sound progression in order to maximize component availability and to minimize the impact of unanticipated results or findings. The risk levels associated with testing will progressively increase with the subsequent completion of test events. Initial testing will be at the M&S level, followed by component/breadboard levels, then evolving into integrated system ground testing (hardware-in-the-loop testing), and finally culminating in flight testing; with the most aggressive test calling for hazardous mid-air engine restarts.

Critical to overall system success, testing of the Hybrid Electric (HE) motor will be conducted during and after initial and final assembly. Flight testing efforts will be divided between two vehicles. Aircraft 1, the ICE only configuration, will be tested with a weight and balance configuration mimicking the weight and balance properties to the HE aircraft. Lessons learned during the ICE aircraft flight test will be utilized in the final development and flight testing of the HE aircraft. Tests that pose little or no threat to the HE engine and/or the airframes will be conducted prior to test points deemed to be higher in risk.

3.2. Evaluation Framework.

Evaluations of the HE-RPA system will focus on the following aspects in order to characterize and evaluate the system against the proposed CONOPS and Critical Operational Issues (COIs).

- (1) Development of the system and processes
- (2) System performance in a developmental context
- (3) Assessment of potential operational capabilities
- (4) Comparison with existing capabilities
- (5) Maturation requirements of high risk technologies

In order to facilitate this system evaluation, testing will be conducted in order to generate the information needed to generate an initial assessment of the system's potential for future development and/or operational use. System testing will be segmented into the three following areas:

- Component/hardware-in-the-loop testing
- Developmental Ground Test
- Developmental Flight Test

Key Requirements and T&E Measures					
Key Reqs	COIs (Critical Operational Issues)	Key MOEs/MOSs (Measures of effectiveness/Suitability)	CTPs & Threshold (Critical Technical Parameters)	Test Methodologies/Key Resources	Decision Supported
KPP#1: (Quiet)	COI #1. Is the HE-RPA effective for quiet operation	Time in HE-mode	Engine and Prop noise	Acoustic Chamber measurement	PDR
		Decibel Levels		Outdoor acoustic ground measurements	CDR
		Loiter Time		Flight acoustic measurements	
KPP #2 (Loiter comparison)	COI #2. Can the HE-RPA loiter as long as a comparable ICE RPA	Regeneration Time Cruise Speed	Loiter Time	Flight measurements	PDR CDR
KPP #3 (Loiter duration)	COI #3. Can the HE-RPA and ICE-RPA loiter long enough to complete a mission	Time of Flight Regeneration Time	Loiter Time	Flight Measurements	PDR CDR

Figure 3.1, Top-Level Evaluation Framework Matrix

3.3. Developmental Evaluation Approach.

Evaluation and testing will follow a progressive approach that coincides with system maturity and an associated level of risk. The projected test sequence and high level test objectives are detailed below.

3.3.1 Component/hardware-in-the-loop testing

Testing will be conducted with prototype or representative items in order to simulate operational conditions and employment scenarios. The primary purpose of the component/hardware-in-the-loop testing is to observe system functionality and to collect and verify system data outputs.

- (1) HE engine test objectives - ICE engine basic function Software in the loop testing
 - a. Torque Maps
 - b. Fuel Consumption Maps
 - c. Verify Positive control of ICE with Motor Controller

- (2) Electric Motor (EM) basic function
 - a. Torque maps
 - b. Energy Consumption Maps
 - c. Verify positive control with Motor Controller
 - d. Propeller Feathering (get the propeller to stop in the same place very time)

- (3) Dual Mode Testing
 - a. Verify torque switch strategy
 - b. Ensure 1-way bearing works
 - c. Verify that the motor can apply additional torque at ICE speed (well matched)
 - d. Verify that the regeneration strategy is appropriate and works
 - e. Check that power takeoff from engine meets recharging requirement
 - f. Fuel consumption maps under dual mode
 - g. Verify positive control of dual mode with motor controller

- (4) HE motor only acoustic testing
 - a. Determine decibel levels for several speeds
 - b. Evaluate effect of cooling

- (5) HE motor and propeller acoustic testing
 - a. Determine decibel levels for several speeds
 - b. Determine decibel levels for several prop configurations

- (6) HE motor endurance testing
 - a. Determine maximum operational time in HE-mode without regeneration
 - b. Determine maximum operational time in HE-mode with regeneration
 - c. Determine optimal battery configuration and discharge strategy

- (7) Engine restart
 - a. Verify ICE engine can be restarted after incremental shutdown time
 - b. Verify ICE engine can be restarted via remote control/wireless command
 - c. Verify engine can be restarted without additional choke adjustments
 - d. Determine system voltage drop due to starter use

- (8) HE mode testing (ICE only, EM only, ICE idle & EM full throttle, ICE and EM full torque, ICE with EM recharge)
 - a. Verify control of magnetos for propulsion system kill
 - b. Verify control of the starter motor
 - c. Verify positive mode control for both propulsion state and electric motor

- (9) Camera component testing
 - a. Determine required voltage for camera switching
 - b. Determine optimal antenna location and configuration

3.3.2 Developmental Ground Testing

The primary purpose of the developmental ground testing is to evaluate the result of integrating the HE propulsion system into the airframe along with the associated

system control components and evaluation of the control strategies. Testing will also focus on data collection only possible via the complete system. Results of the testing will determine the readiness of the system for flight testing.

- (1) System integration test
 - a. HE aircraft and ICE aircraft control surface and throttle testing
 - b. HE mode control with all other electrical systems operating
 - c. Software in the loop testing – automated mode/emergency procedures
 - d. Ground station testing and pre-flight operations checks

- (2) HE and ICE acoustic testing - airframe
 - a. Mounted in air
 - b. Radius on ground

- (3) Operator familiarization and training
 - a. Setup – operational checks
 - b. Operation
 - c. Emergency procedures
 - d. Recovery

- (4) Camera testing
 - a. Range
 - b. Camera switching

3.3.3 Developmental Flight Testing

The first flight tests performed will be performed on a prototype aircraft developed by the contractor. The purpose of the prototype flight test will be to discern the initial airworthiness of the aircraft. Prototype testing may be conducted solely at the discretion of the contractor with results being passed to AFIT.

Additional flight test will be performed on each of the two airframes developed, a basic ICE only configuration and HE configuration with the hybrid-electric propulsion

system. One objective of the project is to show how the HE aircraft compares to a similar ICE aircraft in regards to quiet operation, long loiter time, and fuel efficiency. The purpose of the ICE airframe is to provide a control article for this comparison and provide spare parts if needed for the HE airframe.

The ICE airframe will be delivered in a flight ready configuration and the HE aircraft will require HE motor integration prior to flight. The HE aircraft will initially be flown with a weight and CG configuration matching the HE aircraft. Flight test data will be used in final integration of the HE propulsion system into the HE aircraft. The HE aircraft and the ICE aircraft in an out-of-the-box configuration will be flown under similar flight conditions for comparative purposes.

Finally, the HE aircraft will undergo additional flight testing in order to evaluate the enhanced capabilities of the HE propulsion system.

- (1) Tests to be conducted with both aircraft configurations
 - a. Ground takeoff
 - b. Catapult takeoff (if required)
 - c. Flight mode test (taxi, launch, climb, cruise, loiter, recharge, land)
 - d. PID loop shaping (longitudinal and lateral mode testing)
 - e. Camera tests
 - f. Endurance testing
 - g. Operator familiarization and training
 - h. Software in the loop
 - i. Contingency testing (ex. communication out)
 - j. Acoustic testing at altitude
 - k. Kestral fuel flow meter

- (2) Specific tests to be conducted with ICE aircraft configured with HE weight and CG
 - a. Maximum takeoff weight determination
 - b. HE mode thrust requirement determination

- (3) Specific tests to be conducted with HE aircraft
- a. Fly with different numbers of batteries (config determination and control)
 - b. Aerial restart
 - c. Maximum endurance
 - d. In-flight mode switching
 - e. Remote/auto mode switching

3.4 Test Event and Test Resource summary

Table 3.1 summarizes all planned test events, timing, and the anticipated test location. A breakdown of specific test objective for each event follows.

Table 3.1 Test Event and Test Resource Summary

Fiscal Year	11	11	11	11	11	12	12	TBD
TEST EVENT	IT-A1	IT-A2	IT-A3	IT-A4	IT-A5	IT-A6	IT-A7	
TEST RESOURCE								
Dynamometer Lab	X							
AFIT/WPAFB ground test		X						
Camp Atterbury			X		X	X	X	
WPAFB acoustic test chamber				X				

- (1) TEST EVENT: IT-A1

Location: Ground testing of the HE propulsion system will be done in the dynamometer lab

Tests:

- a. ICE engine basic function Software in the loop testing

- b. Electric Motor (EM) basic function
- c. Dual Mode Testing
- d. HE motor endurance testing
- e. Engine restart
- f. HE mode testing (ICE only, EM only, ICE idle & EM full throttle, ICE and EM full torque, ICE with EM recharge)

Test Objectives:

- a. Torque Maps
- b. Fuel Consumption Maps
- c. Verify Positive control of ICE with Motor Controller
- d. Torque maps
- e. Energy Consumption Maps
- f. Verify positive control with Motor Controller
- g. Propeller Feathering (get the propeller to stop in the same place very time)
- h. Verify torque switch strategy
- i. Ensure 1-way bearing works
- j. Verify that the motor can apply additional torque at ICE speed (well matched)
- k. Verify that the regeneration strategy is appropriate and works
- l. Check that power takeoff from engine meets recharging requirements
- m. Fuel consumption maps under dual mode
- n. Verify positive control of dual mode with motor controller
- o. Verify control of magnetos for propulsion system kill
- p. Verify control of the starter motor
- q. Verify positive mode control for both propulsion state and electric motor

(2) TEST EVENT: IT-A2

Location: Acoustic ground test will primarily be conducted at WPAFB and will consist of indoor and outdoor testing.

Tests:

- a. HE and ICE acoustic testing in an open space outdoors
- b. HE and ICE acoustic testing while mounted in the air

Test Objectives:

- a. The HE motor will be tested in each mode with and without the propeller and will be compared to the acoustic test of the ICE engine with and without the propeller
- b. The HE motor will be tested in each mode with and without the propeller and will be compared to the acoustic test of the ICE engine with and without the propeller

(3) TEST EVENT: IT-A3

Location: Flight testing will be done at Camp Atterbury, IN using restricted air space. The flight tests are ordered to minimize Program Risk. Prior to flight test, the HE and ICE aircraft will undergo system integration, operator familiarization and training, camera testing and control surface verification.

Tests:

- a. Initial ICE-RPA PID loop shaping test in HE weight and balance configuration
- b. Subsequent ICE-RPA testing after PID control is acceptable

Test Objectives:

- a. Ground takeoff
- b. PID loop shaping (longitudinal and lateral mode testing)
- c. Operator familiarization and training
- d. Software in the loop
- e. Camera tests
- f. Kestral fuel flow meter
- g. Catapult takeoff (if required)
- h. Flight mode test (taxi, launch, climb, cruise, loiter, land)
- i. Contingency testing (ex. communication out)
- j. Acoustic testing at altitude
- k. Maximum takeoff weight
- l. Endurance testing

(4) TEST EVENT: IT-A4

Location: EM testing of the HE propulsion system in an indoor acoustic testing facility

Tests:

- a. HE configuration acoustic testing

Test Objectives:

- a. The EM motor will be run with and without the propeller and acoustic measurements will be taken to determine the minimum attainable noise of the HE-RPA.

(5) TEST EVENT: IT-A5 thru IT-A7

Location: Flight testing will be done at Camp Atterbury, IN using restricted air space. Flight tests will be ordered to minimize Program Risk.

Tests:

- b. Initial HE-RPA PID loop shaping test
- c. Subsequent HE-RPA tests
- d. ICE-RPA PID loop shaping test in “out of the box” configuration
- e. Subsequent ICE-RPA performance testing after PID control is acceptable

Test Objectives:

- a. Ground takeoff
- b. PID loop shaping (longitudinal and lateral mode testing)
- c. Operator familiarization and training
- d. Software in the loop
- e. Camera tests
- f. Catapult takeoff (if required)
- g. Contingency testing (ex. communication out)
- h. Acoustic testing at altitude
- i. Fly with different numbers of batteries (configuration determination and control)
- j. Aerial restart
- k. Endurance testing
- l. Kestral fuel flow meter
- m. Flight mode test (taxi, launch, climb, cruise, loiter, land)
- n. Maximum takeoff weight
- o. Endurance testing

3.3.1. Mission-Oriented Approach.

Testing will focus on the KPPs as they are critical to achieving the capabilities covered in the CONOPS. Currently only a developmental system, evaluation of the KPPs will determine the achieved technological maturity level and hence suitability for future operational employment.

3.3.2. Developmental Test Objectives.

The primary purpose of developmental test has been to show proof of concept. By exploring the trade space of the technology under development future decision makers will be able to consider this technology as part of an analysis of alternatives.

Developmental test objectives coincide with key performance parameters.

3.3.3. Modeling & Simulation (M&S).

We plan to use MATLAB/SIMULINK for modeling the aircraft handling qualities and to develop acceptable flight control logic to aid in obtaining initial PID gains to use in the PID loop shaping.

3.3.4. Test Limitations.

A compressed test window will be the primary limitation for testing. Testing must be completed before inclement weather prevents testing at primary flight test range. Testing, data reduction, and analysis must be completed in time form completion of pertinent AFIT master's theses, approximately March 2012.

3.4. Live Fire Test and Evaluation Approach. N/A

3.4.1. Live Fire Test Objectives. N/A

3.4.2. Modeling & Simulation (M&S). N/A

3.4.3. Test Limitations. N/A

3.5. Certification for Initial Operational Test and Evaluation (IOT&E). N/A

3.6. Operational Evaluation Approach. N/A

3.6.1. Operational Test Objectives. N/A

3.6.2. Modeling & Simulation (M&S).

The HE-RPA's flight controls and propulsion system controls will be developed in a virtual environment consisting of MATLAB/SIMULINK in order to generate autopilot parameters. This M&S will minimize the need for baseline airframe characterization and performance evaluation and minimize the overall risk associated with flying a RPA. Initial flight test missions will be dedicated to verification of M&S results. Verification and model and/or system modifications will be performed by AFIT graduate students.

3.6.3. Test Limitations.

Flight testing must be accomplished prior to November 30th 2011 due to anticipated inclement weather conditions at test ranges and personnel availability. Contractor personnel are currently funded to support anticipated test timelines.

Flight testing will be limited to ranges with restricted airspace.

Flight test mission times may be controlled and/or limited by parent organization at test ranges

Only two test vehicles will be produced, potentially limiting testing should the assets become unavailable or unserviceable.

Approval must be pre-coordinated and granted by flight test approval authorities prior to any missions.

3.7. Other Certifications.

Although official flight certifications and/or airworthiness certificates are not required, analysis and preliminary test results will be presented to AFIT and AFRL approval authorities as evidence of airworthiness. Flight test approval will be required prior to each flight test of the HE-RPA.

3.8. Reliability growth.

No specific reliability growth testing is planned.

3.9. Future Test and Evaluation.

LFT&E, IOT&E, and OT&E will not be conducted during this portion of the HE-UAV project.

4. PART IV-RESOURCE SUMMARY

4.1. Introduction.

The resources necessary to facilitate testing include test labs, test ranges, support equipment, and government and contractor personnel support. All systems/components undergoing testing are considered to be prototypes.

Test labs located at AFIT and AFRL will be utilized for developmental testing of the hybrid-electric propulsion system, hardware-in-the-loop testing, and acoustic testing. Propulsion system and airframe integration testing will also be conducted at the AFIT labs.

Full ground testing and flight testing will be conducted at test ranges with airfield access and restricted airspace. The primary flight test location will be Camp Atterbury, IN due to its proximity and experience with testing RPAs and UAVs. As it is a US Army/Joint training center, testing could potentially be interrupted to accommodate the base's primary mission. Test procedures will be developed to accommodate these possible interruptions yet still conduct successful testing. A full list of planned test events is included below.

Test Event	Test Location	Date(s)
Hybrid-electric propulsions system developmental testing	AFIT Labs	Mar 11-Sep 11
Propulsion system integration testing	AFIT Labs	Aug 11 - Sep 11
Flight control/autopilot integration testing	AFIT Labs	Aug-11
Acoustic testing	AFRL Labs	Sep-11
Full scale Ground Testing	Camp Atterbury	31 Aug 2011 - 2 Sep 2011
Aircraft 1 Flight Testing	Camp Atterbury	31 Aug 2011 - 2 Sep 2011
<i>Backup dates for Flight Test of Aircraft 1</i>	<i>Camp Atterbury</i>	<i>28 Sep 2011 - 30 Sep 2011</i>
Aircraft 2 Flight Testing	Camp Atterbury	28 Sep 2011 - 30 Sep 2011

Flight testing dates were chosen to best accommodate anticipated system availability, range availability, availability of contractor support, and to minimize the impact of inclement weather. Currently, backup dates for flight testing are planned as shown.

4.1.1. Test Articles.

One primary hybrid-electric propulsion system will undergo developmental, hardware-in-the-loop, and flight testing with a possible second system as a backup for acoustic testing.

Two aircraft will undergo ground and flight testing. One test article will have and ICE configuration, the other test article will have a HE configuration.

One ground station will be utilized for all ground and flight testing.

All test articles will be considered prototypes.

4.1.2. Test Sites and Instrumentation.

All hardware-in-the-loop testing and a majority of the ground testing will be conducted in AFIT lab. Acoustic testing is planned to be completed in AFRL labs. All flight testing and some full scale ground testing will be conducted at Camp Atterbury. No external instrumentation will be required. All necessary instrumentation is self-contained within the HE-RPA system. Testing will be accomplished IAW the previously noted test schedule.

4.1.3. Test Support Equipment.

Acoustic testing will require AFRL provided recording equipment.

Flight testing will require contractor support from CESE for ground station setup and manning and basic flight testing support to include fuel, battery charging, and aircraft spotting.

HE-RPA will also require the availability of GPS but its availability will be assumed to be present for all testing

4.1.4. Threat Representation. N/A

4.1.5. Test Targets and Expendables. N/A

4.1.6. Operational Force Test Support. N/A

4.1.7. Models, Simulations, and Testbeds.

During DT&E we will use MATLAB/SIMULINK for modeling the complete system and airframe control and performance.

4.1.8. Joint Mission Environment. N/A

4.1.9. Special Requirements.

Preliminary certification from flight test approval authority is required prior to flying the HE-RPA. Additional funds and the associated contract amendment will need to be in place should assistance from airframe developer be deemed necessary for flight testing.

4.2. Federal, State, and Local Requirements.

Flight testing will be conducted in military controlled restricted air space to ensure compliance with these regulations and restrictions. As a result, FAA regulations regarding unmanned vehicle operation will not affect testing.

4.3. Manpower/Personnel and Training.

Military, government, and/or contractor personnel will be involved in all aspects of testing. All personnel will be trained and certified on specific lab equipment as needed. All personnel conducting flight test operations at Camp Atterbury will be required to complete Annual range safety training. Military personnel will develop operating and training material in conjunction with test plans. Emergency and contingency operations will also be developed at that time. All testing will require at least one member to act solely as safety monitor.

Flight testing will require the presence of a support contractor trained and authorized as a manually controlled safety pilot.

No modeling and simulation will be used or developed for training purposes.

4.4. Test Funding Summary.

The principle expense for testing will be in paying for contractor support and test related temporary duty (TDYs) expenses. Funding will be solely provided by AFIT and AFRL (FY-11). AFRL funding will specifically be utilized for developmental testing of the hybrid-electric propulsion system.

Works Cited

- [1] Headquarters, United States Air Force, "United States Air Force Unmanned Aircraft Systems Flight Plan 2009-2047," Washington DC, 2009.
- [2] Office of the Secretary of Defense, "Unmanned Systems Roadmap (2007-2034)," Department of Defense, 2007.
- [3] Office of the Secretary of Defense, "Unmanned Aircraft Systems Roadmap (2005-2030)," Department of Defense, 2005.
- [4] T. Costlow, "Special Forces At The Edge," *Defense Systems, Knowledge Technologies and Net-Enabled Warfare*, pp. 21-26, May 2011.
- [5] Boeing, "Boeing.com," 2011. [Online]. Available: <http://www.boeing.com/defense-space/military/scaneagle/index.html>. [Accessed 15 October 2011].
- [6] Aerosonde, "Aerosonde Mark 4.7: Redefining Expeditionary," Textron Systems Corporation, Hunt Valley, MD, 2010.
- [7] J. Perry, "MQ-5B Hunter, Next Generation Tactical Aerial System," Northrop Grumman Technical Services, 2006.
- [8] AeroVironment, "UAS: Raven," 2011. [Online]. Available: www.avinc.com.

[Accessed 15 Oct 2011].

- [9] National Research Council, "Pre-Milestone A and Early-Phase Systems Engineering," The National Academies Press, Washington, D.C., 2008.
- [10] F. G. Harmon, "Neural Network Control of a Parallel Hybrid-Electric Propulsion System for a Small Unmanned Aerial Vehicle," Davis, CA, 2005.
- [11] F. G. Harmon, A. A. Frank and J.-J. Chattot, "Conceptual Design and Simulation of a Small Hybrid-Electric Unmanned Aerial Vehicle," *Journal of Aircraft*, vol. 43, no. 5, pp. 1490-1498, September-October 2006.
- [12] J. Ausserer, "Integration, Testing, and Validation of a Small Hybrid-Electric Remotely Piloted Aircraft," Dayton, OH, 2012.
- [13] C. Giacomo, "Stability and Control Analysis and PID Tuning for the Condor HE-RPA," Dayton, OH, 2012.
- [14] T. A. Rotramel, "Optimization of Hybrid Electric Propulsion Systems for Small Remotely Piloted Aircraft," Dayton, OH, 2010.
- [15] Department of the Air Force, "Fiscal Year 2012 Air Force Posture Statement," Department of the Air Force, 2011.
- [16] C. R. Sova, "Unmanned Aircraft Systems Center of Excellence," in *Army Aviation Association of America*, Fort Rucker, AL, 2009.

- [17] B. G. Edward M. Reede, Interviewee, *Commander, U.S. Army Special Forces Command*. [Interview]. 8 Oct 2011.
- [18] M. C. Patterson and A. Brescia, "Requirements Driven UAV Development," in *Bristol International Unmanned Aerial Vehicle System Conference*, Bristol, UK, 2007.
- [19] AeroVironment, "UAS: Puma AE," 1 April 2011. [Online]. Available: http://www.avinc.com/uas/small_uas/puma. [Accessed 1 May 2011].
- [20] R. M. Hiserote and F. G. Harmon, "Analysis of Hybrid Electric Propulsion System Designs for Small Unmanned Aircraft Systems," in *46th AIAA/ASME/SAE/ASEE Joint Propulsion conference & Exhibit*, Nashville, TN, 2010.
- [21] Office of the Secretary of Defense, "Unmanned Systems Roadmap (2007-2032)," Department of Defense, 2007.
- [22] J. Koster, C. Humbarger, E. Serani, A. Velazco, D. Hillery, D. Larabee, T. Wormer, J. Marshman, E. Petersen and D. Gaide, "Hybrid Electric Integrated Optimized System (HELIOS): Design of a Hybrid Propulsion System for Aircraft," in *49th AIAA Aerospace Sciences MEeting including the New Horizons Forum and Aerospace Exposition*, Orlando, FL, 2011.
- [23] R. R. Glassock, J. Y. Hung, L. F. Gonzalez and R. A. Walker, "Multimodal Hybrid Powerplant for Unmanned Aerial Systems (UAS) Robotics," in *Twenty-Fourth*

Bristol Internation Unmanned Air Vehicle Systems Conference, Bristol, 2009.

- [24] C. M. Greiser, "Implementation of a Rule-Based Open-Loop Control Strategy for a Hybrid-Electric Propulsions System on a Small RPA," Dayton, OH, 2011.
- [25] I. H. Mengistu, "Small Internal combustion Engine Testing for Hybrid-Electric Remotely Piloted Aircraft Propulsion," Dayton, OH, 2011.
- [26] CLMax Engineering LLC, "CLMax Engineering," CLMax Engineering, 2011.
[Online]. Available: <http://clmaxengineering.com>. [Accessed 2011].
- [27] C. Burger, Propeller Performance Analysis and Multidisciplinary Optimization Using a Genetic Algorithm, Auburn: Auburn University, 2007.
- [28] G. K. K. Gregorek, An Acoustic Sensitivity Study of General Aviation Propellers, Anaheim: Ohio Staet University, 1980.
- [29] K. R. Fidler, "Subsystem Acoustic Testing of a Vertical Takeoff and Landing Ducted Propeller Unmanned Aerial Vehicle," Aviation and Missile Research, Development, and Engineering Center, Redstone Arsenal, AL, 2004.
- [30] A. Anderson, L. de Paula and D. Ohmart, Sound Level Testing of Silver Fox, San Migel: Raytheon, 2010.
- [31] Department of Defense Office of the Deputy Under Secretary of Defense for Acquisition and Technology, "Systems Engineering Guide for Systems of Systems,"

Department of Defense, Washington D.C., 2008.

[32] C. Humphreys, L. Mailloux and G. E. Spear, Systems Engineering Analysis for Transition of the Ground Hardness Technology Demonstrator, Dayton, 2008.

[33] L. Abbott, C. Stillings, C. Phillips and G. Knowlan, Systems Engineering Analysis for Transition of the Fleeting target Technology Demonstrator, Dayton, 2007.

[34] D. o. Defense, "Defense Acquisition Guidebook," Defense Acquisition University, 2011.

[35] DoD, "Operation of the Joint Capabilities Integration and Development System," Chairman of the Joint Chiefs of Staff, 2009.

[36] B. S. Blanchard and W. J. Fabrycky, Systems Engineering and Analysis, Upper Saddle River: Prentice Hall, 2011.

[37] J. M. Nicholas and H. Steyn, Project Management for Businesses, Engineering, and Technology, Amsterdam: Elsevier, 2008.

[38] Procerus Technologies, "Kestrel Users Guide," Procerus Technologies, Vineyard, UT, 2007.

[39] R. M. Hiserote, "Analysis of Hybrid-Electric Propulsion System Designs for Small Unmanned Aircraft Systems," Dayton, OH, 2010.

[40] Ivie Technologies Inc., *IE-45 Audio Analysis System Owner's and Operator's Manual*, Lehi, UT: Ivie Technologies Inc., 2007.

[41] M. Spottswood, "AFIT UAV Propeller/Motor Acoustic Characterization," Spottswood, Michael, Wright-Patterson AFB, OH, 2011.

REPORT DOCUMENTATION PAGE			<i>Form Approved OMB No. 074-0188</i>		
<p>The public reporting burden for this collection of information is estimated to average 1 hour per response, including the time for reviewing instructions, searching existing data sources, gathering and maintaining the data needed, and completing and reviewing the collection of information. Send comments regarding this burden estimate or any other aspect of the collection of information, including suggestions for reducing this burden to Department of Defense, Washington Headquarters Services, Directorate for Information Operations and Reports (0704-0188), 1215 Jefferson Davis Highway, Suite 1204, Arlington, VA 22202-4302. Respondents should be aware that notwithstanding any other provision of law, no person shall be subject to an penalty for failing to comply with a collection of information if it does not display a currently valid OMB control number.</p> <p>PLEASE DO NOT RETURN YOUR FORM TO THE ABOVE ADDRESS.</p>					
1. REPORT DATE (DD-MM-YYYY) 22 March 2012		2. REPORT TYPE Master's Thesis		3. DATES COVERED (From - To) Sep 2010 - March 2012	
4. TITLE AND SUBTITLE Rapid Prototype Development of a Remotely-Piloted Aircraft Powered by a Hybrid-Electric propulsion system			5a. CONTRACT NUMBER		
			5b. GRANT NUMBER		
			5c. PROGRAM ELEMENT NUMBER		
6. AUTHOR(S) Molesworth, Michael P., Capt, USAF English, Jacob K., Capt, USAF			5d. PROJECT NUMBER		
			5e. TASK NUMBER		
			5f. WORK UNIT NUMBER		
7. PERFORMING ORGANIZATION NAMES(S) AND ADDRESS(S) Air Force Institute of Technology Graduate School of Engineering and Management (AFIT/EN) 2950 Hobson Way WPAFB OH 45433-7765			8. PERFORMING ORGANIZATION REPORT NUMBER AFIT/GSE/ENV/12-M02		
9. SPONSORING/MONITORING AGENCY NAME(S) AND ADDRESS(ES) DDR&E/Systems Engineering Crystal Mall 3 suite 102 1851 South Bell St. Arlington, VA 22202 POC: Don Gelosh Phone(703)602-0851x126 Donald.Gelosh@osd.mil			10. SPONSOR/MONITOR'S ACRONYM(S) OSD		
			11. SPONSOR/MONITOR'S REPORT NUMBER(S)		
12. DISTRIBUTION/AVAILABILITY STATEMENT Distribution Statement A. APPROVED FOR PUBLIC RELEASE; DISTRIBUTION UNLIMITED.					
13. SUPPLEMENTARY NOTES This material is declared a work of the U.S. Government and is not subject to copyright protection in the United States.					
14. ABSTRACT Today, Remotely-Piloted Aircraft (RPA) provide users with unique mission capabilities, particularly on-demand overhead surveillance. However, a capability gap has been identified between the range and endurance of RPAs powered by internal combustion engines (ICE) and the reduced acoustic signature and smaller logistical footprint associated with electric-powered RPAs. This research, sponsored by the Office of the Secretary of Defense, aims at advancing systems engineering education by evaluating the utility of a tailored systems engineering approach. The tailored systems engineering approach used herein focuses on conducting a concept evaluation study on the rapid prototype development of a parallel hybrid-electric RPA (HE-RPA) and its ability to fill an identified mission capability gap. The concept evaluation utilizes a tailored systems engineering process to conduct a rapid prototype development and system evaluation. Two prototype RPAs and a support system are designed, integrated, and tested within a 13 month time window, in accordance with an established architectural framework. The integration of a parallel hybrid-electric system into an RPA demonstrated a potential reduction in acoustic signature and improves endurance over electric powered RPAs; however, immature technology and added system complexity result in overall performance that is currently on par with ICE-powered RPAs and only partially satisfies the capability gap.					
15. SUBJECT TERMS RPA, tailored systems engineering, concept evaluation, architecture, risk analysis					
16. SECURITY CLASSIFICATION OF:			17. LIMITATION OF ABSTRACT	18. NUMBER OF PAGES	19a. NAME OF RESPONSIBLE PERSON
a. REPORT	b. ABSTRACT	c. THIS PAGE			Dr. David R. Jacques (ENV)
U	U	U	UU	270	19b. TELEPHONE NUMBER (Include area code) (937)255-3636, ext 3329 Email: david.jacques@afit.edu (ENV)

Standard Form 298 (Rev. 8-98)
Prescribed by ANSI Std. Z39-18